

**PIGRECO**

# Pigreco structure

en\_The Design Concept of Pigreco worked on aesthetics but also on easy assembling and quick installation process that result particularly easy and intuitive. The cable management can be effected when the workstation is completely assembled. We highlight the maximum span of 3600 mm between the side legs.

it\_Il Concept Design di Pigreco ha lavorato sull'estetica, ma anche sulla facilità di montaggio ed assemblaggio che risultano particolarmente semplici ed intuitivi. Il posizionamento dei cavi, che di solito viene eseguito a strutture semiallestite, interrompendo così il lavoro di assemblaggio, può essere effettuato, invece, a bench completamente montati. Si evidenziano la luce massima tra le due gambe fino a 3600 mm.

fr\_Le Concept Design de Pigreco a travaillé sur l'esthétique, mais aussi sur la facilité d'installation et de montage qui sont particulièrement simples et intuitives. Le positionnement des cables, qui a habituellement lieu à des structures partiellement montées en bloquant le travail de montage, peut être effectuée une fois le bench est complètement monté. En évidence le maximum de décalage entre les deux pieds aux extrémités allant jusqu'à 3600 mm.



## Pigreco leg / Gamba Pigreco / Pied Pigreco



en\_Single Leg  
it\_Gamba singola  
fr\_Pied individuel



053 Bianco



069 Titanio



051 Nero

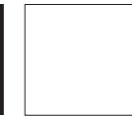

LAC  
17 colours



003 Rovere  
massello



060 Cromo

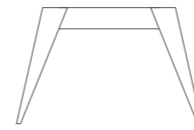

en\_Bridge Leg  
it\_Gamba ponte  
fr\_Pied arche



053 Bianco



069 Titanio



051 Nero



LAC  
17 colours



003 Rovere  
massello



032 WO-BI

## Pigreco Loop leg / Gamba Loop Pigreco / Pied Pigreco Loop



en\_Desk Leg  
it\_Gamba per scrivania  
fr\_Pied pour bureau



en\_Bench Leg  
it\_Gamba per bench  
fr\_Pied pour bench



053 Bianco



069 Titanio



051 Nero



LAC  
17 colours

## Leg for high table / Gamba per tavolo alto / Pied pour table haute



800



051 Nero

# Desk

en\_Desks are the essential part of office furniture. Their aesthetic and functional role is the focus in the workspace organization. Available with Pigreco leg or Loop leg, in different sizes, shapes and finishes allow a wide aesthetic and functional choice.

it\_Le scrivanie sono la parte essenziale dell'arredo ufficio. Il loro ruolo estetico e funzionale è un punto chiave nell'organizzazione dello spazio di lavoro. Disponibili con gamba Pigreco o Loop, in diverse dimensioni, forme e finiture permettono un'ampia scelta estetica e funzionale.

fr\_Les bureaux sont la partie essentielle de l'aménagement du bureau, leur rôle esthétique et fonctionnel est un point clé dans l'organisation de l'espace de travail. Disponible avec pied Pigreco ou Loop, en différentes dimensions, formes et finitions permettent un large choix esthétique et fonctionnel.

## Desk with Pigreco Leg / Scrivanie con gamba Pigreco / Bureau avec pied Pigreco

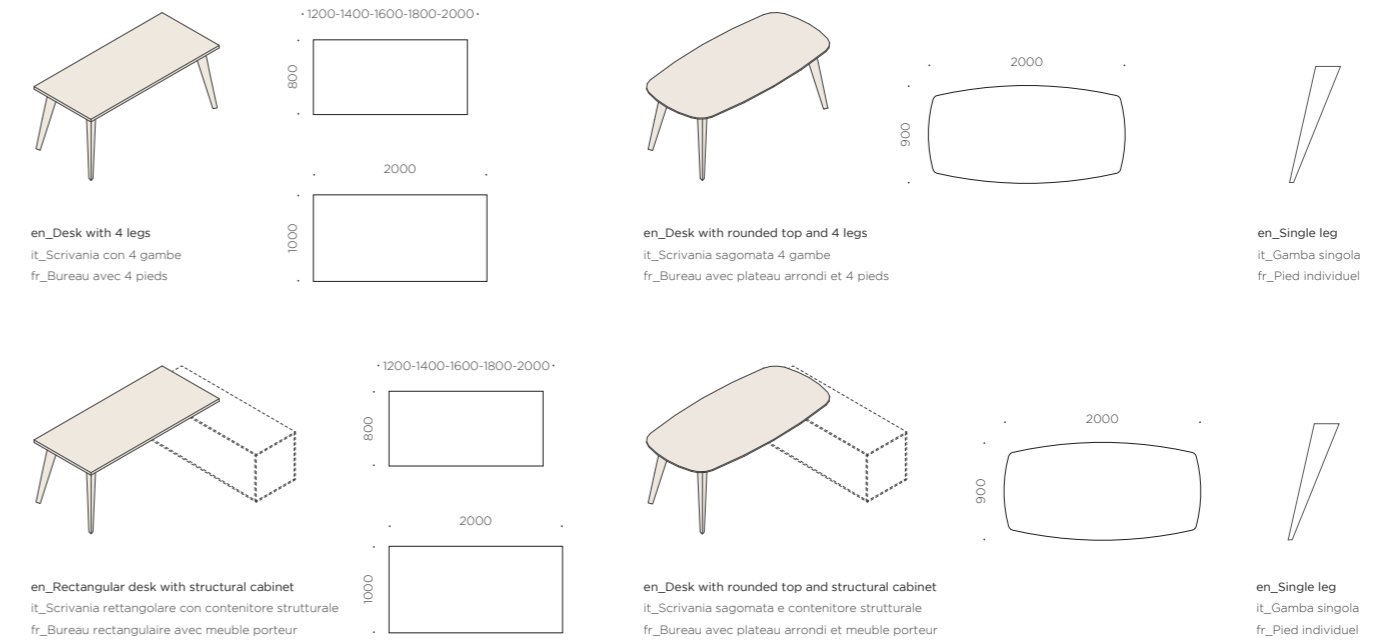

## Desks with Pigreco Loop leg / Scrivanie con gamba Pigreco Loop / Bureau avec pied Pigreco Loop

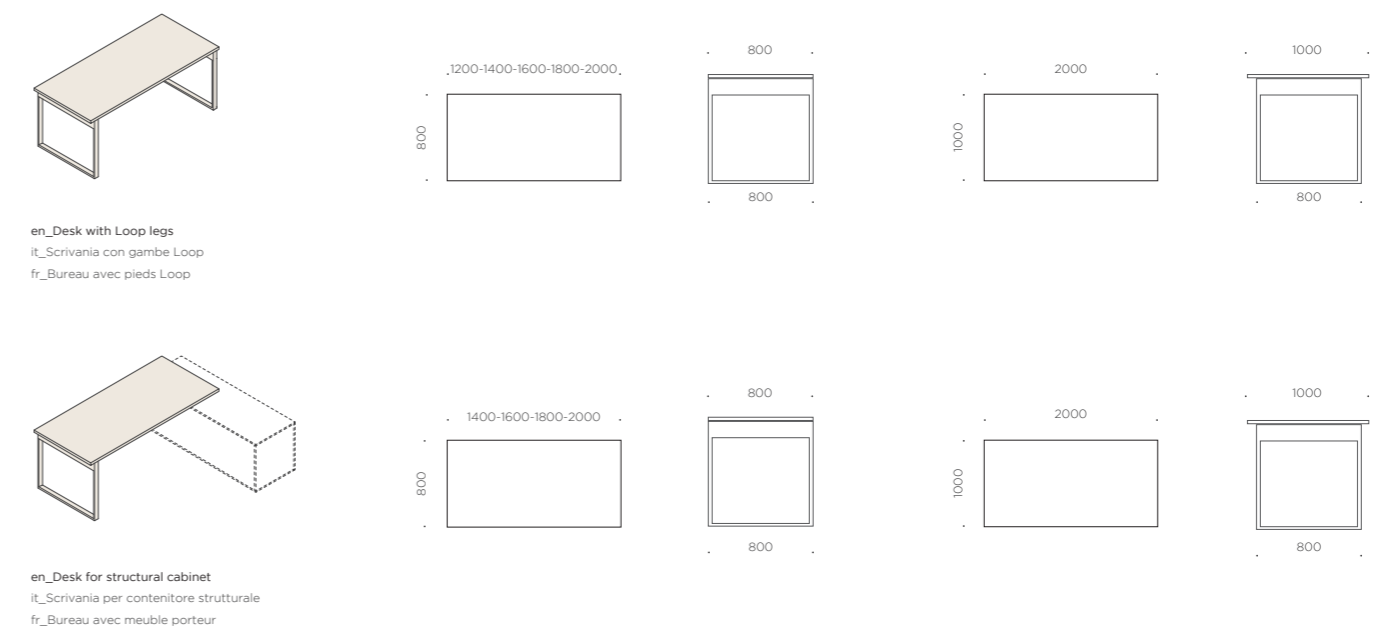

# Bench Pigreco leg

en\_With Pigreco bench it is possible to create compositions up to lengths of 3600 mm without intermediate leg.

it\_Con i bench Pigreco si possono creare composizioni fino a lunghezze di 3600 mm senza gamba intermedia.

fr\_Avec Pigreco composition bench avec longueurs jusqu'à 3600 mm sin pied intermédiaire.

## Bench with single legs / Bench con gamba singola / Bench avec pied individuel

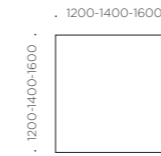
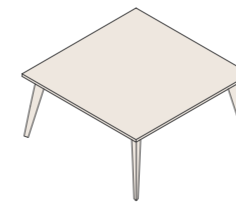

en\_Bench  
it\_Bench  
fr\_Bench

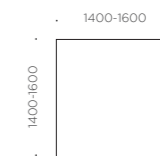
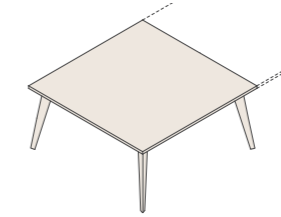

en\_Bench  
it\_Bench  
fr\_Bench



en\_Single leg  
it\_Gamba singola  
fr\_Pied individuel



## Bench with bridge legs / Bench con gamba a ponte / Bench avec piétements arche

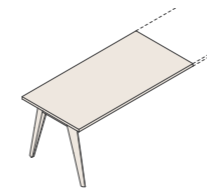

en\_Bench with bridge leg W. 800 mm  
it\_Bench gamba a ponte L. 800 mm  
fr\_Bench avec piétements arche L. 800 mm

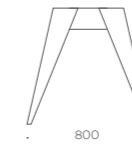

en\_Bridge Leg  
it\_Gamba ponte  
fr\_Piétements arche

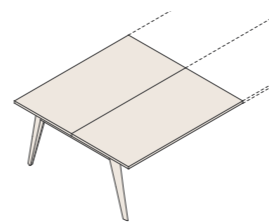

en\_Bench with bridge leg W. 1400 mm  
it\_Bench gamba a ponte L. 1400 mm  
fr\_Bench avec piétements arche L. 1400 mm

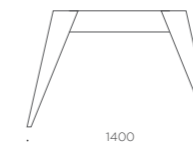

en\_Bridge Leg  
it\_Gamba ponte  
fr\_Piétements arche

# Bench Loop leg

en\_Bench desks are ideal for furnishing open-plan environments or offices where team work is preferred. At any time can be equipped with screen or storage units.

it\_Le scrivanie multiple composte da scrivanie a due posti o più, sono ideali per arredare ambienti open space o uffici in cui si predilige il lavoro di squadra. Le postazioni multiple vengono suddivise grazie a pannelli separatori e necessitano molte volte di un contenimento a bordo scrivania.

fr\_L'exigence la plus grande dans l'organisation des salles opérationnelles est l'ergonomie, unie à l'optimisation de la place en relation aux fonctions. Cette section comprend: bureaux opérationnels individuels, bench, systèmes avec station centrale, cloisons de séparation.

## Bench / Bench / Bench

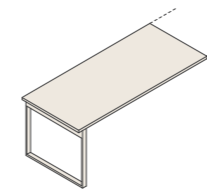

en\_Bench Loop legs  
it\_Bench gamba Loop  
fr\_Bench pied Loop

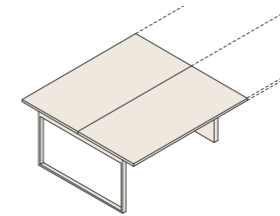
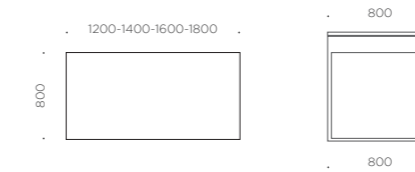

en\_Bench Loop legs  
it\_Bench gamba Loop  
fr\_Bench pied Loop

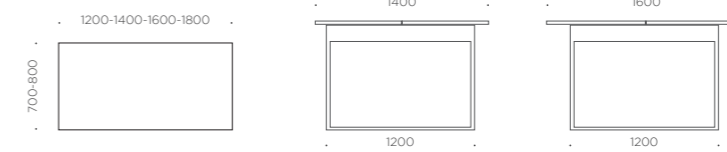

# Screen

en\_In open space areas, screen partitions for desks are very useful for dividing workstations and ensuring the privacy of those who use them. They can be in wood or upholstered in fabric, and can be equipped with accessory bars as paper trays, pen holders or monitor holders.

it\_Nelle aree open space, i pannelli divisori per scrivanie sono molto utili per dividere le postazioni e garantire la privacy di chi le utilizza. Possono essere in legno o rivestiti in tessuto e possono essere attrezzati con barre per aggancio di vaschette portadocumenti, portapenne o portamonitor.

fr\_Dans les zones à espace ouvert, les cloisonnettes de séparation pour bureaux sont très utiles pour séparer les postes de travail et garantir l'intimité de ceux qui les utilisent. Ceux-ci peuvent être en bois ou revêtus en tissu ou peuvent être équipés avec des barres pour accrocher des porte-documents, des porte-crayons ou des porte-écrans.



## Front screen / Screen frontali / Cloisonnette frontale

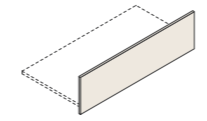

en\_Screen th. 18 mm for single desk  
it\_Screen sp. 18 mm per scrivania singola  
fr\_Cloisonnette ép. 18 mm pour bureau

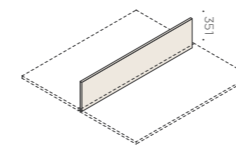

en\_Screen for bench sp. 18 mm  
it\_Screen per bench sp. 18 mm  
fr\_Cloisonnette ép. 18 mm pour bench

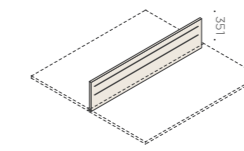
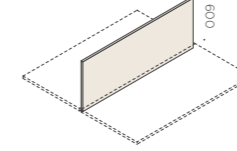

en\_Screen th. 30 mm for bench  
it\_Screen sp. 30 mm per bench  
fr\_Cloisonnette ép. 30 mm pour bench

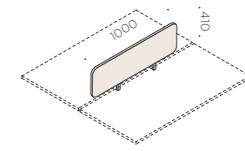

en\_Nucleo screen for bench  
it\_Screen Nucleo per bench  
fr\_Cloisonnette Nucleo pour bench

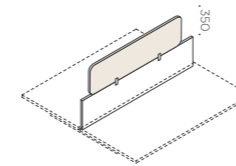

en\_Screen extension  
it\_Divisorio sopra screen  
fr\_Rehausse pour cloisonnette

## Screen laterale / Lateral screen / Cloisonnette latérale

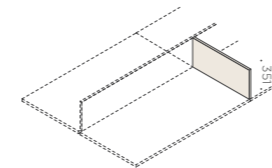

en\_Fixed screen th. 18 mm  
it\_Screen fisso sp. 18 mm  
fr\_Cloisonnette fixe ép. 18 mm

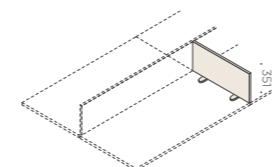
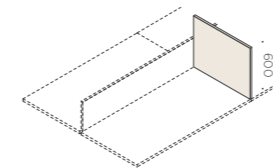

en\_Screen freestanding th. 18 mm  
it\_Screen freestanding sp. 18 mm  
fr\_Cloisonnette laterale freestanding ép. 18 mm

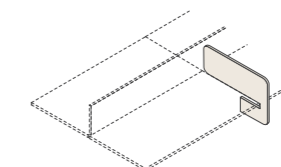
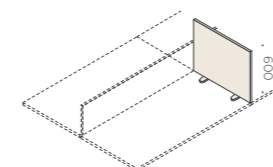

en\_Movable screen  
it\_Screen Movable  
fr\_Cloisonnette Movable

# Meeting table Pigreco leg

en\_The rigor of the wide span without supports transmits a sense of order and clean lines, and gives the space a strong and unique personality.  
Small meeting areas can be elegantly furnished, in addition to the classic round or square tables, with new functional shapes with the rounded shaped table top.

it\_Il rigore dell'ampia campata senza sostegni a terra trasmette ordine e pulizia formale e dona all'ambiente una personalità forte ed esclusiva.  
Le piccole aree riunioni oltre ai classici tavoli rotondi o quadrati, possono essere finemente arredate con le nuove funzionali geometrie dei tavoli sagomati.

fr\_La rigueur de la grande poutre sans pied intermédiaire transmet ordre et propreté et donne à l'environnement une personnalité forte et exclusive.  
Les petites zones réunions peuvent être aménagée, en plus des tables rondes ou carrées classiques, avec les nouvelles géométries de la table avec plateau arrondi.



## Meeting table with 4 legs / Tavoli riunione con 4 gambe / Table de réunion avec 4 pieds

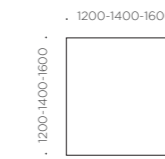
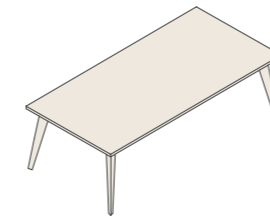

en\_Meeting tables with 4 legs  
it\_Tavolo riunioni con 4 gambe  
fr\_Table réunion avec 4 pieds



en\_Single Leg  
it\_Gamba singola  
fr\_Pied individuel

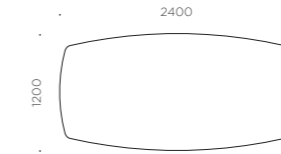
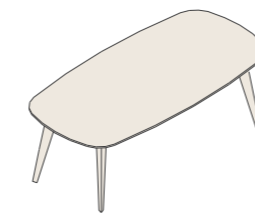

en\_Meeting table with rounded top and 4 legs  
it\_Tavolo riunioni sagomato 4 gambe  
fr\_Table réunion avec plateau arrondi et 4 pieds



en\_Single Leg  
it\_Gamba singola  
fr\_Pied individuel

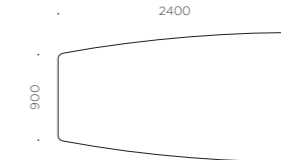
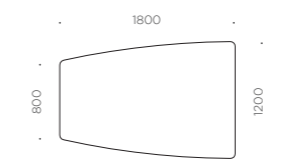
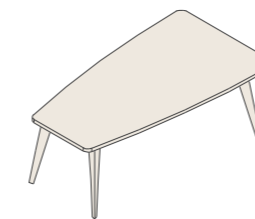

en\_Meeting table with trapezoidal top and 4 legs  
it\_Tavolo riunioni trapezoidale 4 gambe  
fr\_Table réunion avec plateau trapézoïdale et 4 pieds



en\_Single Leg  
it\_Gamba singola  
fr\_Pied individuel

## Meeting table with bridge legs / Tavoli riunione con gamba a ponte / Table de réunion avec piétements arche

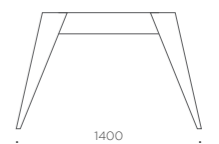
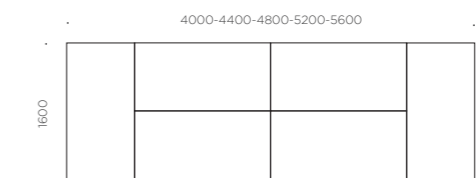
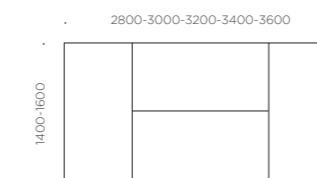
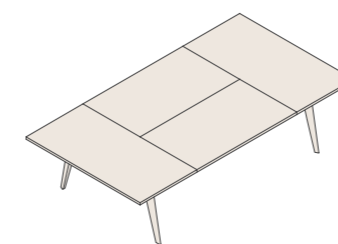

en\_Meeting table with bridge leg  
it\_Tavolo riunione gamba a ponte  
fr\_Table de réunion avec piétements arche

en\_Bridge Leg  
it\_Gamba ponte  
fr\_Piétements arche

# Meeting table Loop leg and High Table

en\_In the office environment areas where people can meet and work together, such as meeting rooms and common areas where people can relax, and communicate, are increasingly important. In these spaces, in addition to solutions with meeting tables with a classic design, high tables can be proposed to facilitate socialization among people.

it\_Sempre di più nell'ambiente ufficio sono importanti le aree dove le persone si possano incontrare e lavorare insieme, come le sale meeting e aree comuni dove le persone possono rilassarsi, comunicare, fare pause. In questi spazi oltre a soluzioni con tavoli riunioni dalla classica conformazione, si possono proporre tavoli alti che facilitano la socializzazione tra le persone.

fr\_Dans l'environnement de bureau, les espaces où les gens peuvent se rencontrer et travailler ensemble, sont de plus en plus importants; salles de réunion et espaces communs où les gens peuvent se détendre, communiquer et faire des pauses. Dans ces espaces, en plus des solutions avec des tables de réunion au design classique, des tables hautes peuvent être proposées pour faciliter la socialisation.



## Meeting table / Tavoli riunione / Table de réunion

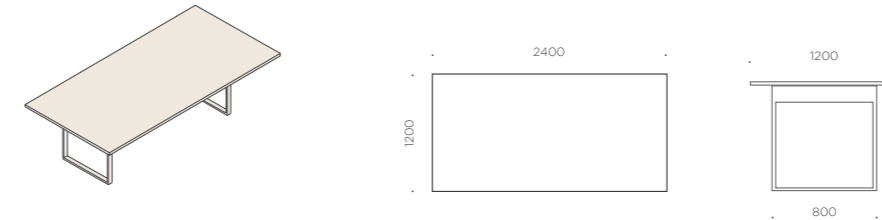

en\_Meeting table  
it\_Tavolo riunione  
fr\_Table de réunion

## Meeting table / Tavolo riunione / Table de réunion

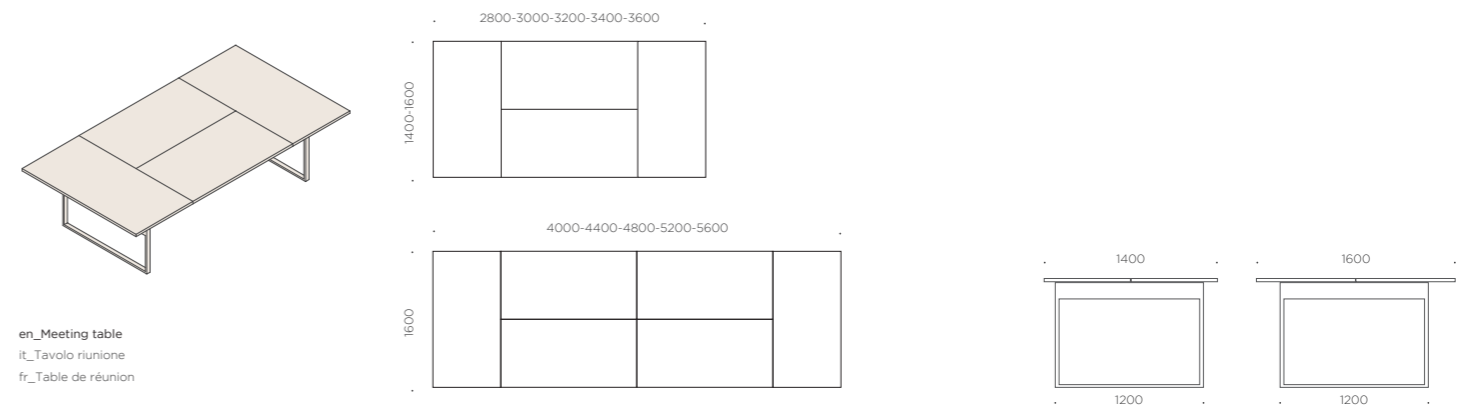

en\_Meeting table  
it\_Tavolo riunione  
fr\_Table de réunion

## High table / Tavolo alto / Table haute

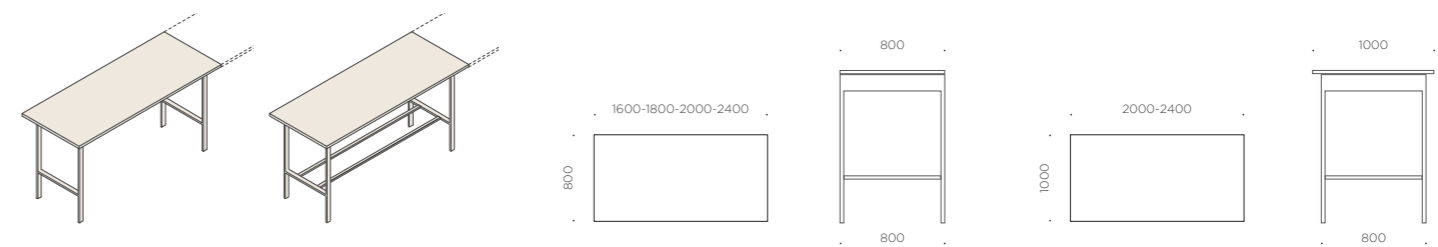

en\_High table  
it\_Tavolo alto  
fr\_Table haute

en\_High table with footrest  
it\_Tavolo alto con poggiatesta  
fr\_Table haute avec repose-pieds



# Pedestals and desk storage

en\_Mobile or fixed office pedestal with drawers or filing drawers, in melamine or metal, single or double sided, represent a universe of offers that select the solution that best suit the requirements. All the office pedestals have centralized locking system with different encrypted lock.

it\_Cassettiere per ufficio nomadi e fisse, con cassetti o classificatori, in melaminico o metallo, mono e bifacciali, rappresentano un universo di proposte che consentono di scegliere la soluzione che meglio si adatta alle proprie necessità.

fr\_Les meubles à tiroirs mobiles et fixes, avec tiroirs ou classeurs, en mélaminé ou métal, à une ou deux faces, représentent un univers de propositions permettant de choisir la solution qui s'adapte le mieux à ses propres nécessités.

## Metal Pedestals / Cassettiere metaliche / Caissons métal

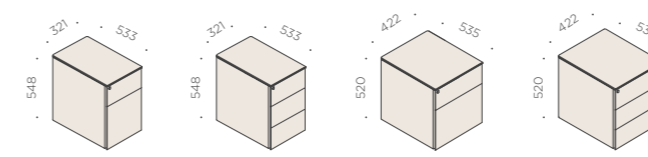

en\_Metal pedestal on castors  
it\_Cassettiere in metallo su ruote  
fr\_Caisson métalliques sur roulettes

## Melamine Pedestals / Cassettiere melaminiche / Caissons mélaminé

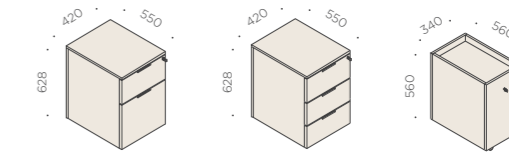

en\_Melamine pedestal on castors  
it\_Cassettiere melaminica su ruote  
fr\_Caisson mélamine sur roulettes

## Structural cabinet / Contenitore strutturale / Meuble porteur

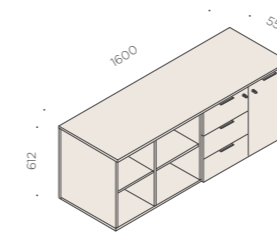

en\_Structural cabinet  
it\_Contenitore strutturale  
fr\_Meuble porteur

## Side cabinet / Contenitori laterali / Meuble latéral

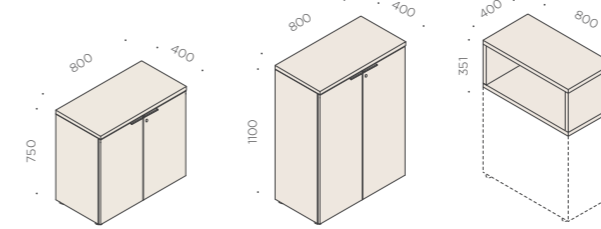

en\_Side cabinet  
it\_Contenitore laterale  
fr\_Meuble latéral

en\_Side cabinet  
it\_Contenitore laterale  
fr\_Meuble latéral

en\_Open box  
it\_Box a giorno  
fr\_Niche ouverte

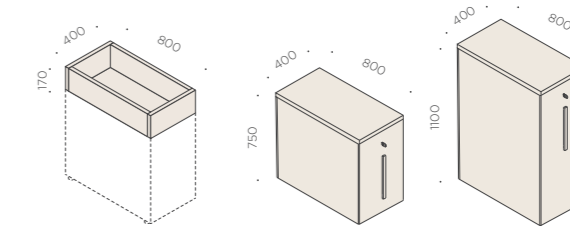

en\_Planter box  
it\_Fioriera  
fr\_Pot à fleurs

en\_Low Orgatower  
it\_Orgatower basso  
fr\_Orgatower basse

en\_High Orgatower  
it\_Orgatower alto  
fr\_Orgatower haut



# Bookshelf

en\_Martex bookshelf is available in 3 heights and 3 widths and can be floor standing or wall mounted.

it\_La Libreria di Martex con mensole e colonne può essere a terra o appesa disponibile in 3 altezze e 3 lunghezze.

fr\_La bibliothèque de Martex avec étagères et colonnes peut être posée au sol ou suspendue. Disponible en 3 hauteurs et 3 longueurs.

## Floor standing bookshelf with shelves / Libreria a terra con mensole / Bibliothèque au sol avec étagères

en\_Options: sides, backs  
it\_Opzioni: fianchi, schiene  
fr\_Options: côtés, dos

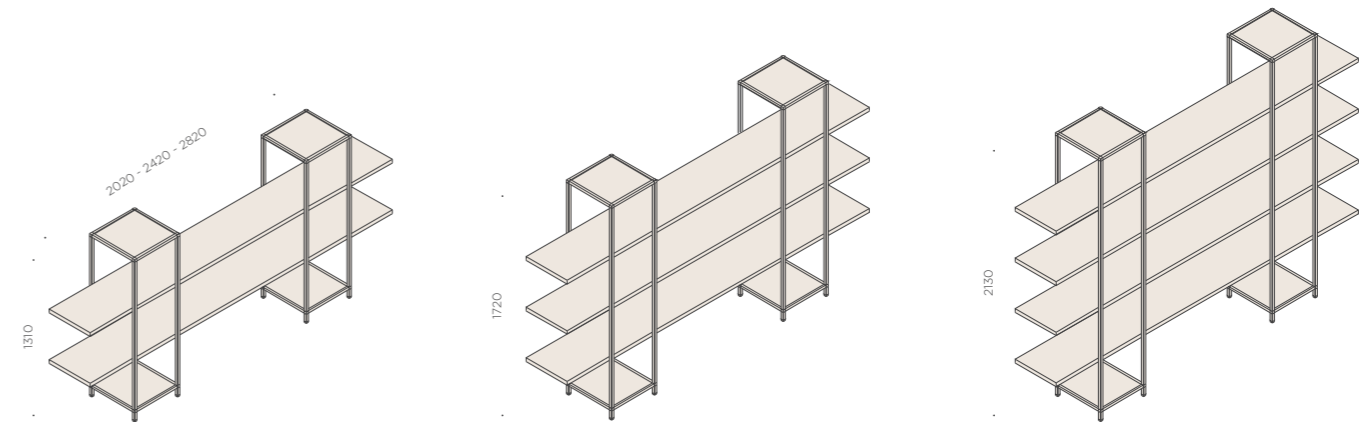

## Wall mounted bookshelf with shelves / Libreria appesa con mensole / Bibliothèque suspendues avec étagères

en\_Options: sides, backs  
it\_Opzioni: fianchi, schiene  
fr\_Options: côtés, dos

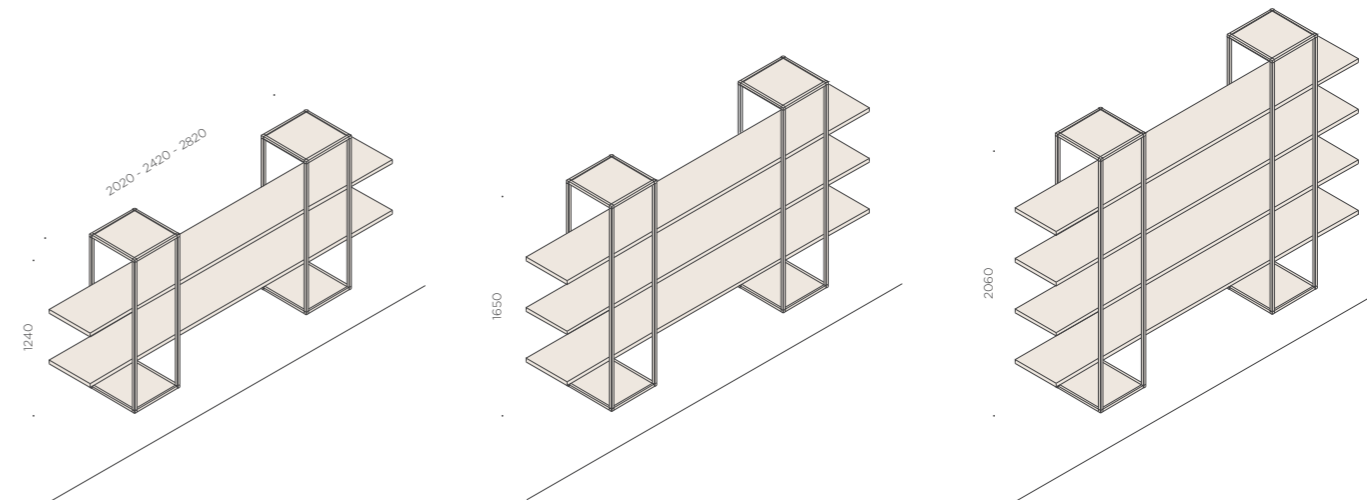

# Modular Bookshelf

en\_Modular bookshelf by Martex is a versatile system composed by a metal frame, where shelves, backs, drawers, doors, planter box, cushions and TV module can be added.

it\_La Libreria modulare di Martex è un sistema versatile costituito da un telaio metallico, a cui possono essere aggiunti ripiani, schiene, cassetti, cestoni, ante, fioriere, cuscini e vani porta tv.

fr\_La bibliothèque modulaire de Martex est un système polyvalent composé d'un cadre en métal, auquel peuvent être ajoutées des étagères, dossiers, tiroirs, portes, pot à fleurs, coussins et module pour téléviseur.

## Modular floor bookshelf / Libreria componibile a terra / Bibliothèque modulaire au sol

en\_Options: portes, côtés, dossiers, 2 tiroirs + 1 tiroir  
 it\_Opzioni: ante, fianchi, schiene, 2 cassetti + 1 cassettona  
 fr\_Options: portes, côtés, dossiers, 2 tiroirs + 1 tiroir

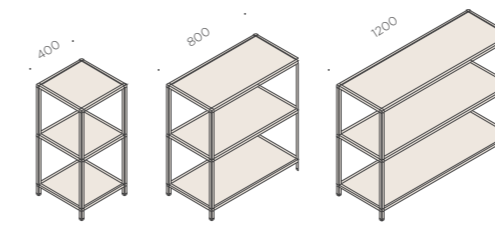

en\_Module widths  
 it\_Larghezze moduli  
 fr\_Largeurs de module

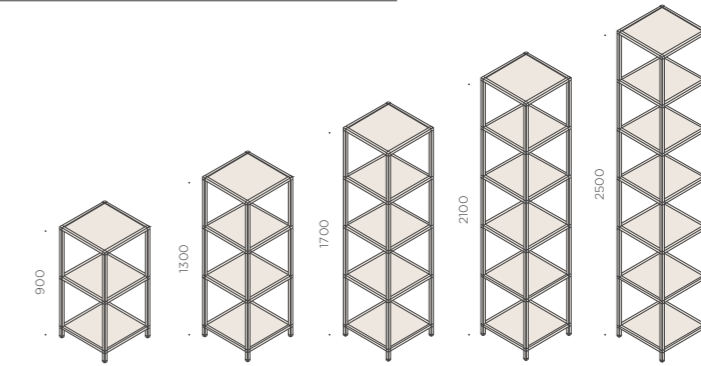

en\_Module height  
 it\_Altezze moduli  
 fr\_Hauteur du module

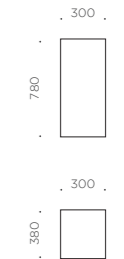

en\_Compartment  
 it\_Vani  
 fr\_Espace de rangement

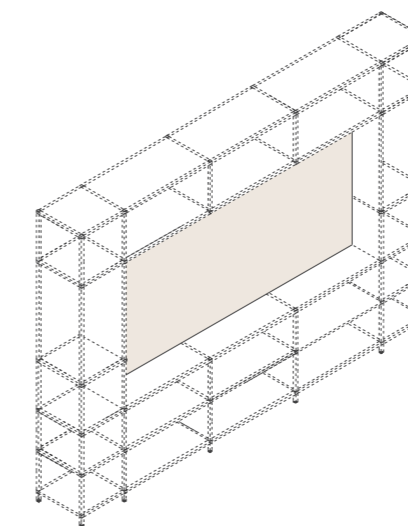

en\_TV module  
 it\_Modulo porta TV  
 fr\_Module meuble TV



en\_TV module  
 it\_Modulo porta TV  
 fr\_Module meuble TV



en\_TV module electrification  
 it\_Elettificazione modulo porta TV  
 fr\_Electrification du module meuble TV

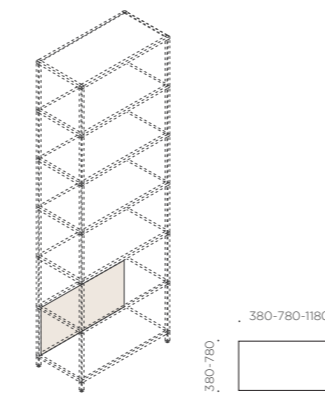

en\_Back  
 it\_Schiena  
 fr\_Dos

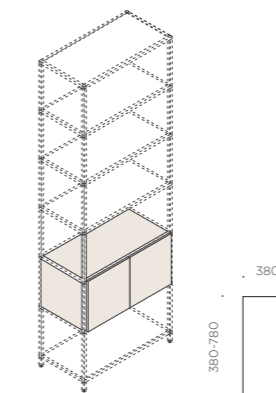

en\_Doors  
 it\_Ante  
 fr\_Portes

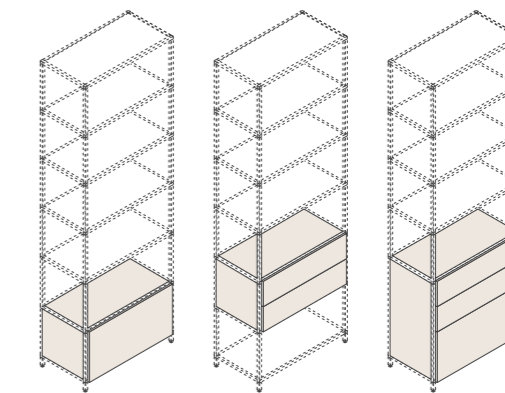

en\_Drawers  
 it\_Cassetti  
 fr\_Tiroirs



# Wire management

en\_There are several solutions proposed to better electrify desks and tables meetings so that the workstations remain clean and with easy access to power.

it\_Diverse sono le soluzioni proposte per elettrificare al meglio scrivanie e tavoli riunioni in modo che le postazioni risultino pulite e con un agevole accesso alle prese elettriche.

fr\_Plusieurs solutions sont proposées pour mieux électrifier les bureaux et les tables réunions afin que les postes de travail soient propres et avec un accès facile aux prises électriques.

## Pigreco / Pigreco / Pigreco



en\_Cable raise through Pigreco leg and leg cover  
it\_Carter per salita cavi su gamba Pigreco  
fr\_Cache câbles pour remontée dans le pied Pigreco

## Salita cavi per bench o tavolo riunioni / Salita cavi per bench e tavolo riunioni / Remontée des câbles por bench et tables réunion



en\_Central metal box (not structural)  
it\_Colonna elettrificabile in metallo (non strutturale)  
fr\_Colonne en métal (non structurel)



en\_Central structural cable tower upholstered in technical fabric  
it\_Gamba strutturale centrale elettrificabile rivestita in tessuto tecnico  
fr\_Pied central structurel électrifiable revêtu en tissu technique



en\_Central structural cable tower upholstered in technical fabric  
it\_Gamba strutturale centrale elettrificabile rivestita in tessuto tecnico  
fr\_Pied central structurel électrifiable revêtu en tissu technique

## Elettrificazione sopra piano / Elettrificazione sopra piano / Câblage au-dessus du plateau



en\_Cable port type C  
it\_Passacavo tipo C  
fr\_Top access type C



en\_Flipper  
it\_Flipper  
fr\_Flipper



en\_Flap in top finishing type Q  
it\_Sportello in finitura tipo Q  
fr\_Top access en finition type Q



en\_Scallop  
it\_Scaloppa  
fr\_Échancrure



en\_Flip top  
it\_Flip top  
fr\_Flip top



en\_Cable port type I  
it\_Passacavo tipo I  
fr\_Prise type I



# Standard Colours & Finishes

en\_Colours for reference only and may vary from original. Fabrics and leathers from different lots may be subject to colour variations. Any differences will not be recognized as a complaint.

it\_Campioni colore indicativi, possono differire dall'originale. Tessuti e pelli possono essere soggetti a cambiamenti e a differenze tra lotti diversi. Eventuali differenze non verranno riconosciute come reclamo.

fr\_Echantillons de coloris indicatifs, ils peuvent différer de l'original. Tissu et cuir de différents lots peuvent être soumis à des changements et à des différences de couleur. Les éventuelles différences ne seront pas reconnus comme une grief.

## MEL - MELAMINICO / MELAMINE / MÉLAMINE



## MEL BC - MELAMINICO BICOLOR / BICOLOR MELAMINE / MÉLAMINE BICOLOR



## LAC - LACCATO OPACO / MATT LACQUERED / LAQUÉ MAT

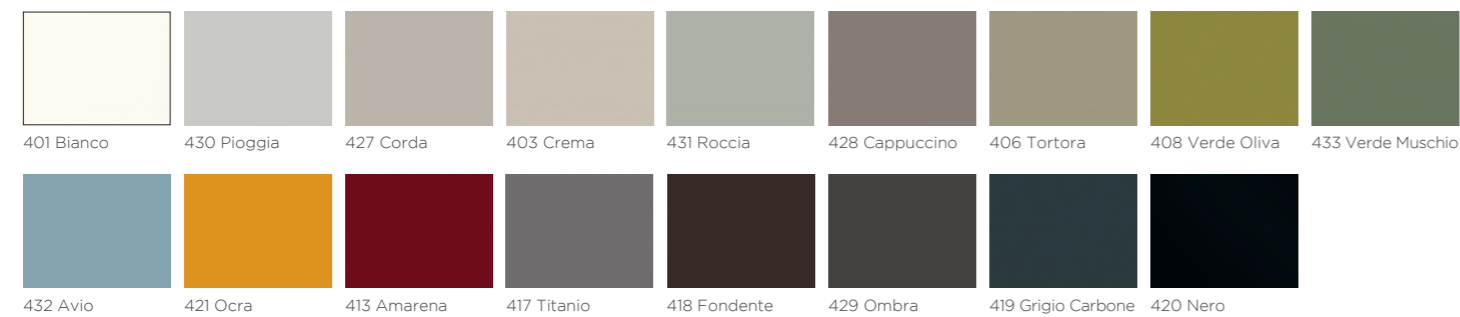

## CAT. C - TESSUTO ANGEL / FABRIC ANGEL / TISSU ANGEL

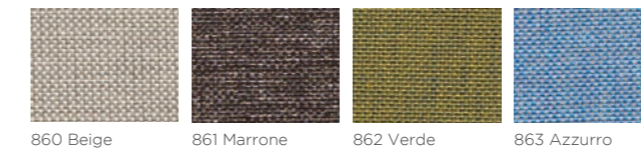

## CAT. D - TESSUTO JET / FABRIC JET / TISSU JET

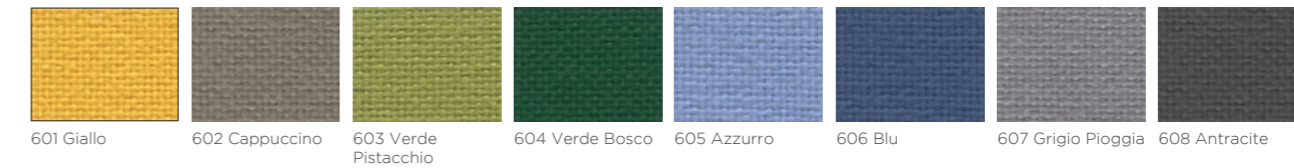

## CAT. D+ - TESSUTO JET BIOACTIVE / FABRIC JET BIOACTIVE / TISSU JET BIOACTIVE

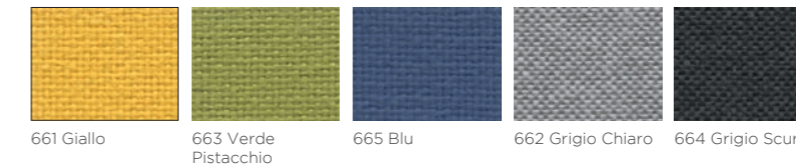

## CAT. H - TESSUTO LUNA 2 / FABRIC LUNA 2 / TISSU LUNA 2

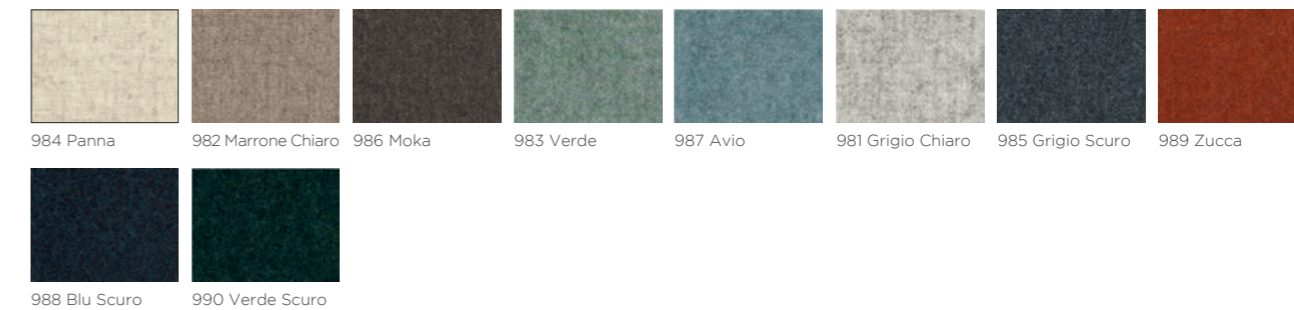

## CAT. I - TESSUTO CAPTURE / FABRIC CAPTURE / TISSU CAPTURE

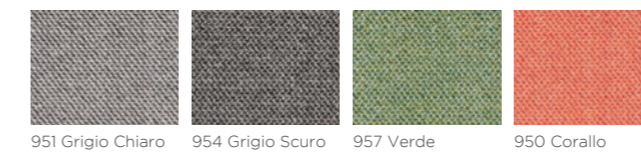

## CAT. L - TESSUTO MAIN LINE FLAX / FABRIC MAIN LINE FLAX / TISSU MAIN LINE FLAX

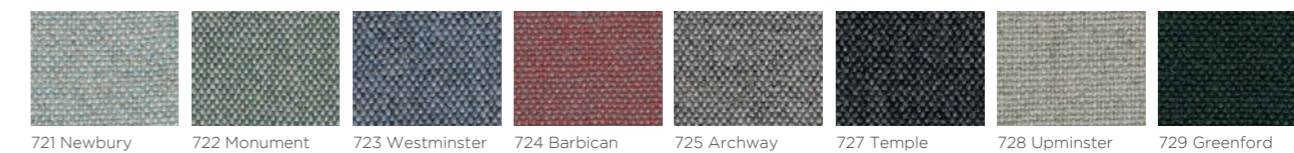

## CAT. M - TESSUTO MERIT / FABRIC MERIT / TISSU MERIT

