

# Entity **Finiture cromatiche** Colour finishing

Piani di lavoro Entity in melaminico sp. 18 mm con bordi in ABS sp. 2 mm.

Entity melamine working tops 18 mm thick with 2 mm ABS edges.

Plans de travail Entity en mélaminé ép. 18 mm avec chants en ABS ép. 2 mm.

Tischplatten Entity in Melamin St. 18 mm mit ABS-Kanten St. 2 mm.

Sobres de trabajo Entity en melamina 18 mm de grosor con cantos en ABS 2 mm de grosor.

Plano de trabalho em melamínico com espessura de 18 mm com bordos em ABS com espessura de 2 mm.

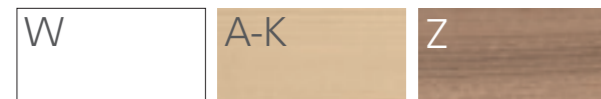

Bianco - White  
Blanc - Weiß  
Blanco - Branco

Acero - Maple  
Erable - Ahorn  
Arce - Bordô

Noce - Walnut  
Noyer - Nussbaum  
Nogal - Nogueira

Strutture metalliche disponibili nei colori bianco o alluminio.

Metal structures available in white or aluminium colours.

Structures métalliques disponibles dans les coloris blanc ou aluminium.

Metallstrukturen in den Farben Weiß oder Aluminium verfügbar.

Estructuras metálicas disponibles en los colores blanco o aluminio.

Estruturas metálicas disponíveis nas cores branco ou alumínio.



Bianco - White  
Blanc - Weiß  
Blanco - Branco

Alluminio  
Aluminium  
Aluminium  
Aluminium  
Aluminium

Frontal panels / Frontal panels  
Panneaux frontaux / Sichtblenden  
Paneles frontales / Painéis frontais



Bianco - White  
Blanc - Weiß  
Blanco - Branco



Verde - Green  
Vert - Grün  
Verde - Verde

Colore frontal panels  
in vetro o in melaminico.  
Colour of glass or  
melamine frontal panels.  
Couleur panneaux écran  
en verre ou en mélaminé.  
Farbe der Sichtblenden  
aus Glas oder Melamin.  
Color paneles frontales  
en cristal o melamina.  
Em vidro ou melanina.

Colore frontal panels  
in vetro o in tessuto.  
Colour of glass or  
fabric frontal panels.  
Couleur panneaux écran  
en verre ou en tissu.  
Farbe der Sichtblenden  
aus Glas oder Stoff.  
Color paneles frontales  
en cristal o tejido.  
Em vidro ou em tecido.



Maniglia di serie per cassettiere melaminico bianco e acero,  
per contenitori complanari e multiuso.

Standard handle for white or maple melamine pedestals,  
for desk-level or multi-purpose storage units.

Poignée standard pour caisson en mélaminé blanc et érable,  
pour armoires coplanaire et polyvalentes.

Standardgriff für Schubladenelemente aus Melamin in Weiß  
und Ahorn, für Schränke mit komplanaren Schiebetüren  
und Mehrzweck-Schränke.

Tirador de serie para cajoneras en melamina blanco o arce,  
para contenedores coplanarios y multiuso.

Puxador de série para gaveteiro melamínico branco e bordô,  
para armários nivelados e multiuso.



Maniglia di serie per cassettiere noce, acero e contenitori-armadi.  
Standard handle for walnut or maple melamine pedestals and  
for storage units.

Poignée standard pour caisson en noyerz, érable et armoires.  
Standardgriff für Schubladenelemente in Nussbaum  
und Ahorn und für Schränke.

Tirador de serie para cajoneras nogal, arce y contenedores-armarios.  
Puxador de série para gaveteiro em nogueira, bordô e arquivos.

# Entity

## ENTITY

### TAVOLI SCRIVANIA P 65 - DESKS 65 DEPTH

P 65 - H 72

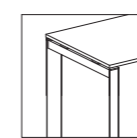

**NNA0080\_** L 80  
**NNA0100\_** L 100  
**NNA0120\_** L 120  
**NNA0140\_** L 140  
**NNA0160\_** L 160  
**NNA0180\_** L 180  
**NNA0200\_** L 200

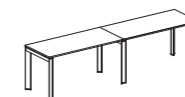

**NNA0142\_** L 280  
**NNA0162\_** L 320

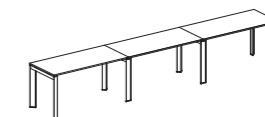

**NNA0143\_** L 420  
**NNA0163\_** L 480

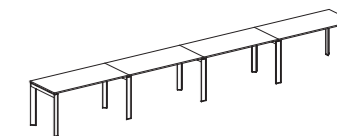

**NNA0144\_** L 560  
**NNA0164\_** L 640

### TAVOLI SCRIVANIA P 80 - DESKS 80 DEPTH

P 80 - H 72

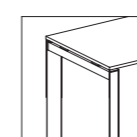

**NNB0080\_** L 80  
**NNB0100\_** L 100  
**NNB0120\_** L 120  
**NNB0140\_** L 140  
**NNB0160\_** L 160  
**NNB0180\_** L 180  
**NNB0200\_** L 200

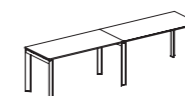

**NNB0142\_** L 280  
**NNB0162\_** L 320

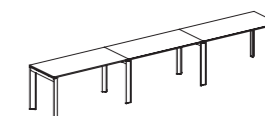

**NNB0143\_** L 420  
**NNB0163\_** L 480

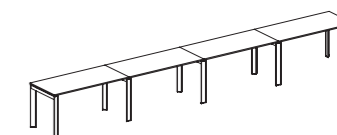

**NNB0144\_** L 560  
**NNB0164\_** L 640

### TAVOLI SCRIVANIA CON PROFILO SINGOLO ATTREZZABILE P 80,5 - DESKS 80.5 DEPTH WITH SINGLE ACCESSORIES PROFILE

P 80,5 - H 72

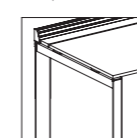

**NNC0080\_** L 80  
**NNC0100\_** L 100  
**NNC0120\_** L 120  
**NNC0140\_** L 140  
**NNC0160\_** L 160  
**NNC0180\_** L 180  
**NNC0200\_** L 200

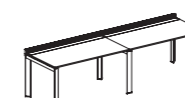

**NNC0142\_** L 280  
**NNC0162\_** L 320

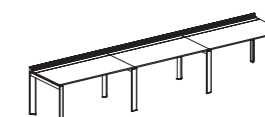

**NNC0143\_** L 420  
**NNC0163\_** L 480

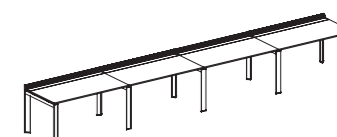

**NNC0144\_** L 560  
**NNC0164\_** L 640

### TAVOLI A 2 SCRIVANIE CONTRAPPOSTE CON PROFILO DOPPIO ATTREZZABILE P 158 - COMPOSITION WITH TWO EXACT OPPOSITE DESKS 158 DEPTH WITH DOUBLE ACCESSORIES PROFILE

P 158 - H 72

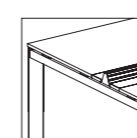

**NND0080\_** L 80  
**NND0100\_** L 100  
**NND0120\_** L 120  
**NND0140\_** L 140  
**NND0160\_** L 160  
**NND0180\_** L 180  
**NND0200\_** L 200



**NND0142\_** L 280  
**NND0162\_** L 320

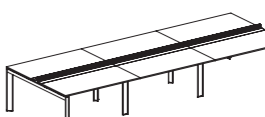

**NND0143\_** L 420  
**NND0163\_** L 480

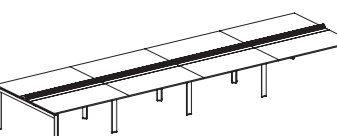

**NND0144\_** L 560  
**NND0164\_** L 640

### TAVOLI A 2 SCRIVANIE CONTRAPPOSTE CON PIANO CENTRALE TOP ACCESS P 158 - COMPOSITION WITH TWO EXACT OPPOSITE DESKS 158 DEPTH WITH CENTRAL TOP AND TOP-ACCESS

P 158 - H 72

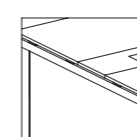

**NNE0140\_** L 140  
**NNE0160\_** L 160  
**NNE0180\_** L 180  
**NNE0200\_** L 200



**NNE0142\_** L 280  
**NNE0162\_** L 320

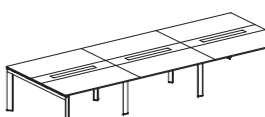

**NNE0143\_** L 420  
**NNE0163\_** L 480

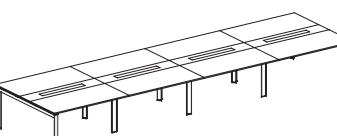

**NNE0144\_** L 560  
**NNE0164\_** L 640

### TAVOLI A 2 SCRIVANIE CONTRAPPOSTE P 166,5 - COMPOSITION WITH TWO EXACT OPPOSITE DESKS 166.5 DEPTH

P 166,5 - H 72

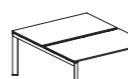
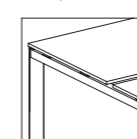

**NNF0080\_** L 80  
**NNF0100\_** L 100  
**NNF0120\_** L 120  
**NNF0140\_** L 140  
**NNF0160\_** L 160  
**NNF0180\_** L 180  
**NNF0200\_** L 200



**NNF0142\_** L 280  
**NNF0162\_** L 320

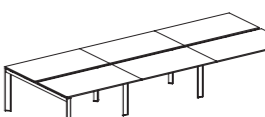

**NNF0143\_** L 420  
**NNF0163\_** L 480

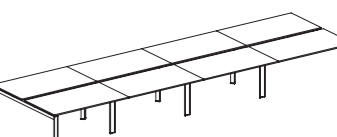

**NNF0144\_** L 560  
**NNF0164\_** L 640

# ENTITY

## ALLUNGHI - EXTENSIONS

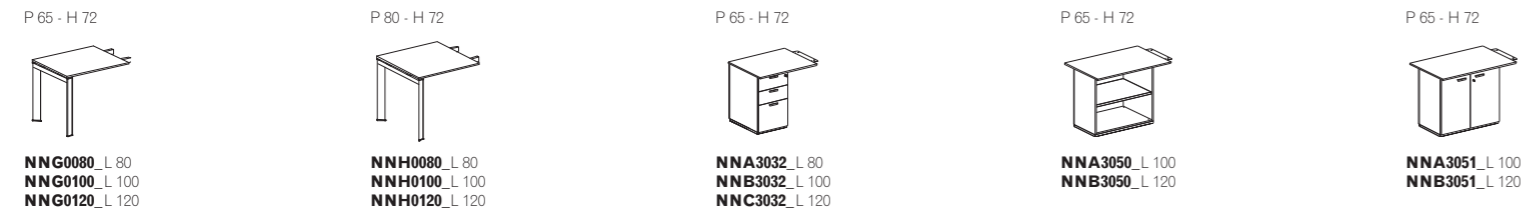

## CONTENITORI MULTIUSO - MULTIPURPOSES STORAGE UNITS

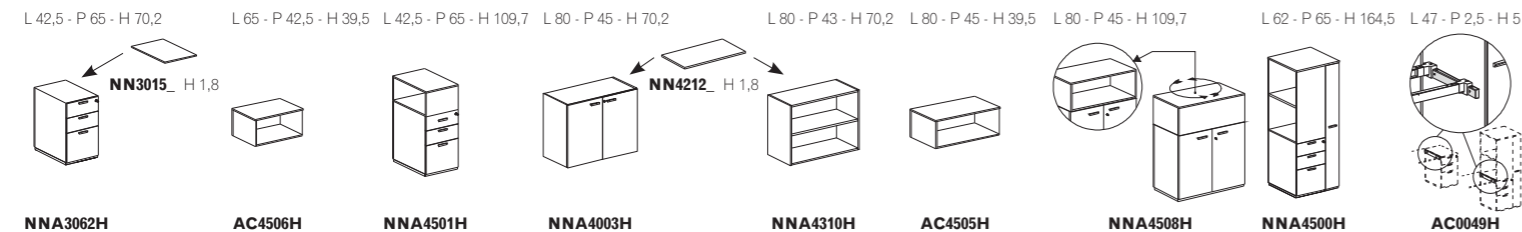

## CASSETTIERE - PEDESTALS

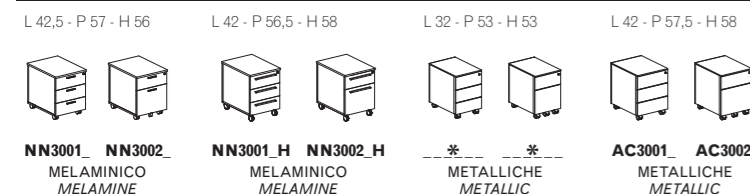

## MOBILE DI SERVIZIO - SERVICE UNIT



## MODESTY PANELS

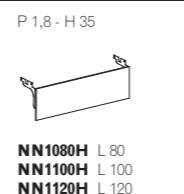

## PORTA DOX - TOP BOX

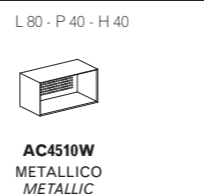

## COMPONENTI PER TAVOLI - COMPONENTS FOR DESKS

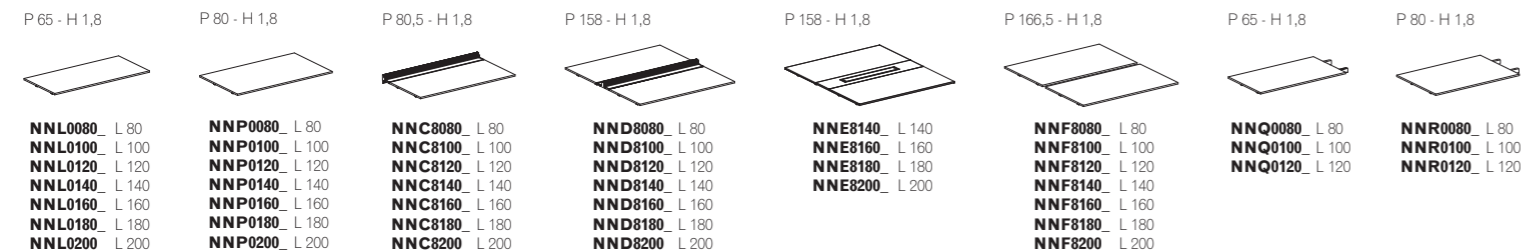

## GAMBE FISSE - FIX LEGS

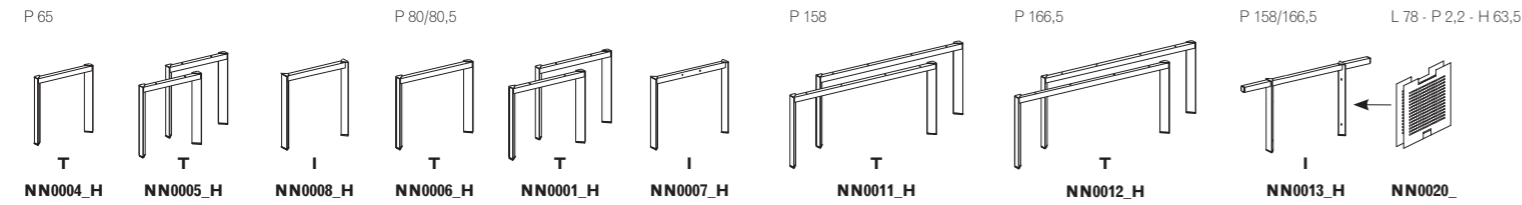

## GAMBE REGOLABILI H min. 62 ÷ max. 85 - ADJUSTABLE LEGS H min. 62 ÷ max. 85

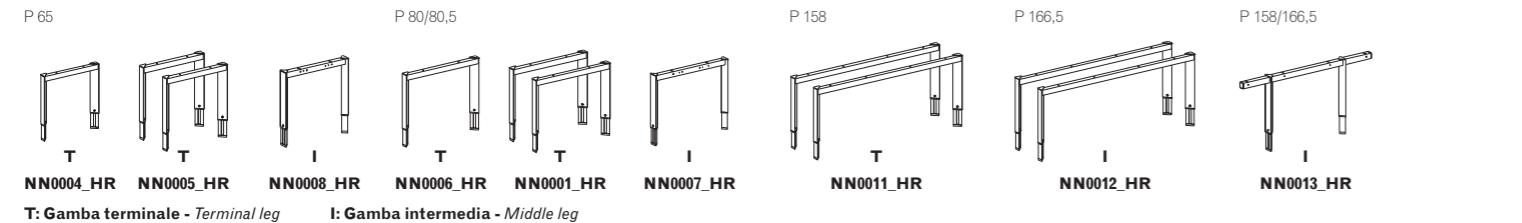

T: Gamba terminale - Terminal leg I: Gamba intermedia - Middle leg

N.B.: LE DIMENSIONI SONO ESPRESSE IN CM. CONSULTARE IL LISTINO PREZZI PER LE CARATTERISTICHE TECNICHE, I CODICI DEGLI ARTICOLI E DELLE FINITURE.  
 N.B.: THE DIMENSIONS ARE STATED IN CM. FOR TECHNICAL CHARACTERISTICS, ARTICLE CODE NUMBERS AND FINISHING, SEE PRICE LIST.

# ENTITY

## COMPONENTI PER ELEVAZIONE ALTEZZA DA 72 A 73,5 CM - COMPONENTS FOR ADJUSTABLE HEIGHT FROM 72 UP TO 73,5 CM

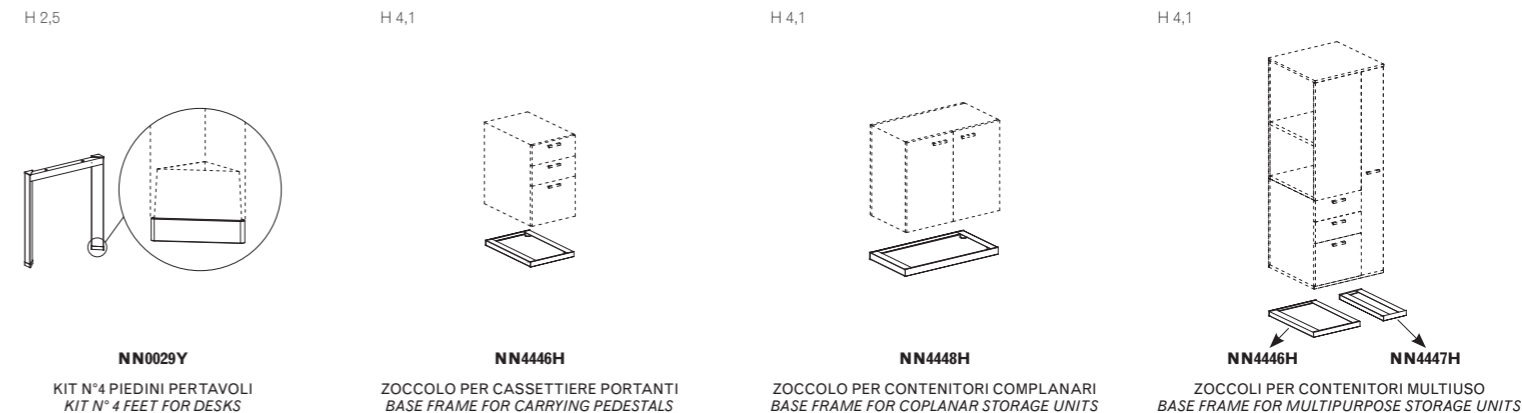

## FRONTAL PANELS PER PROFILI ATTEZZABILI - FRONTAL PANELS FOR EXTRUDED ACCESSORIES PROFILE

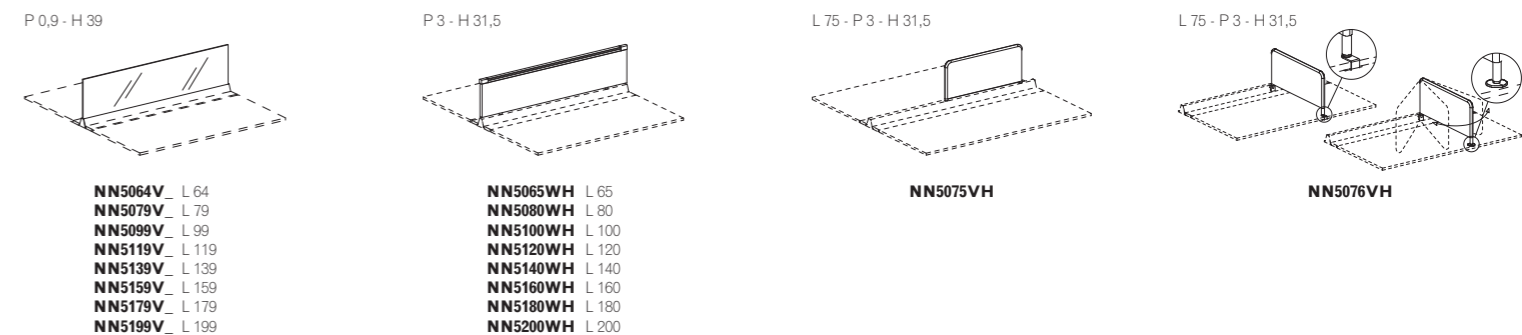

## FRONTAL PANELS CON MORSETTI - FRONTAL PANELS WITH CLAMPS

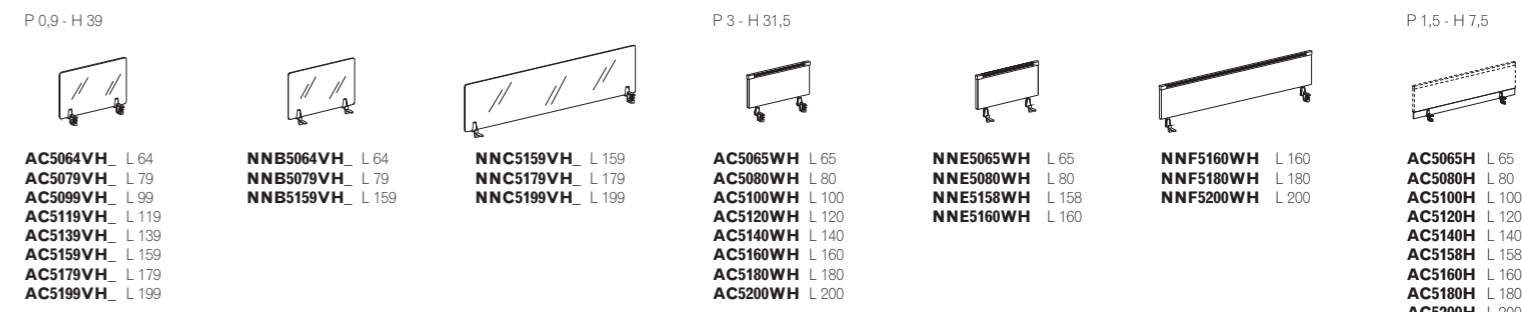

## ACCESSORI PER FRONTAL PANELS IN MELAMINICO - ACCESSORIES FOR MELAMINE FRONTAL PANELS

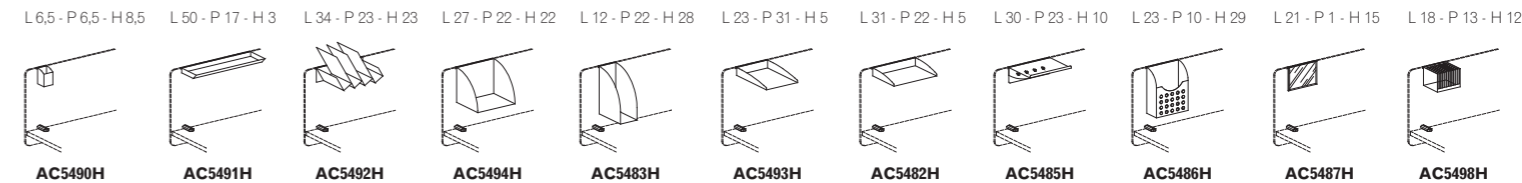

## ACCESSORI PER PROFILI ATTEZZABILI - ACCESSORIES FOR ACCESSORIES PROFILE

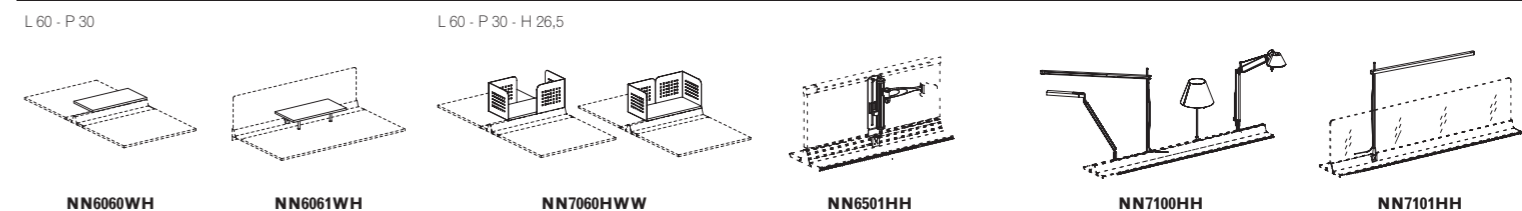

N.B.: LE DIMENSIONI SONO ESPRESSE IN CM. CONSULTARE IL LISTINO PREZZI PER LE CARATTERISTICHE TECNICHE, I CODICI DEGLI ARTICOLI E DELLE FINITURE.  
 N.B.: THE DIMENSIONS ARE STATED IN CM. FOR TECHNICAL CHARACTERISTICS, ARTICLE CODE NUMBERS AND FINISHING, SEE PRICE LIST.

