

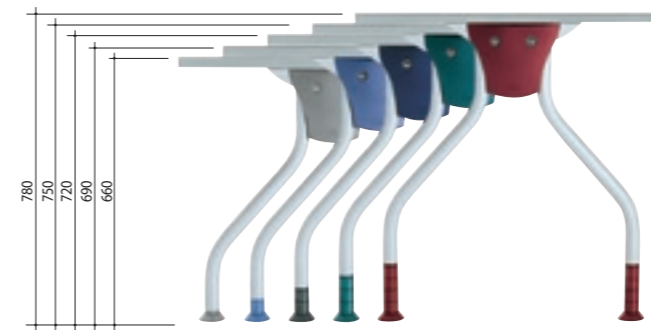

Bull **Regolazione in altezza** Adjustment in height

Réglage en hauteur / Höhenverstellung / Altura regulable / Regulagem de altura

*Mediante kit di anelli in ABS colorato avvitabili tra di loro è possibile regolare l'altezza dei tavoli da 66 a 78 cm con passo di 3 cm.
 The screw-in ring kit in coloured ABS is designed to adjust the height of tables from 66 to 78 cm, with pitch of 3 cm.
 A l'aide du kit anneaux en ABS couleur se vissant entre eux, il est possible de régler la hauteur des plateaux de 66 à 78 cm avec un pas de 3 cm.
 Die Tischhöhe kann mit den farbigen ABS-Ringen, die untereinander verschraubt werden können, jeweils im 3-cm-Abstand zwischen 66 und 78 cm eingestellt werden.
 Mediante el kit de anillos en ABS de colores, enroscables entre sí, es posible regular la altura de las mesas de 66 a 78 cm, con paso de 3 cm.
 Utilizando um conjunto de anéis em ABS colorido, parafusáveis entre eles, é possível regular a altura das mesas de 66 a 78 cm com passo de 3 cm.*



*Regolazione gamba metallica.
 Adjusting the metal leg.
 Réglage du pied métallique.
 Einstellung des Metallbeins.
 Regulación pata metálica.
 Regulagem do pé metálica.*

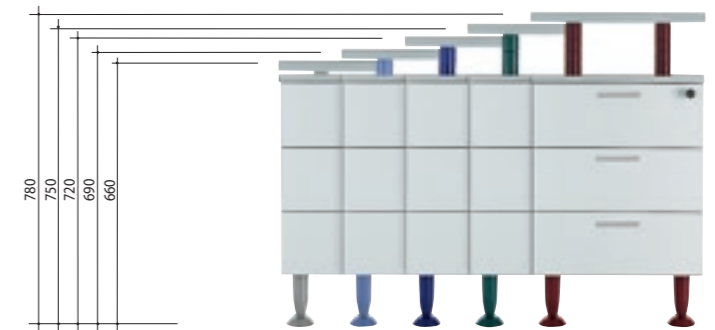

*Regolazione cassettiera portante.
 Adjusting the carrying pedestal.
 Réglage du caisson porteur.
 Einstellung des tragenden Schubladenelements.
 Regulación cajonera portante.
 Regulagem do gaveteiro pedestal.*

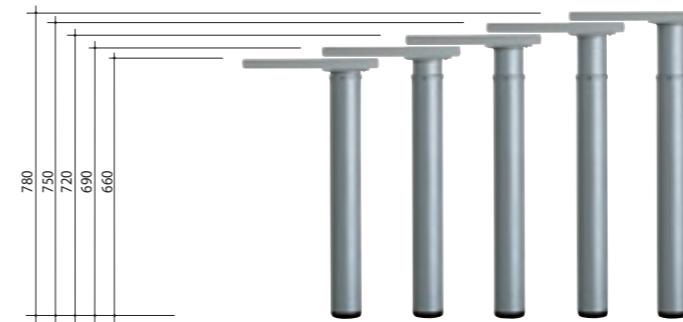

*Colonna telescopica regolabile.
 Adjustable telescopic column.
 Pied colonne télescopique réglable.
 Einstellbare Teleskopsäule.
 Columna telescópica regulable.
 Coluna telescópica regulável.*

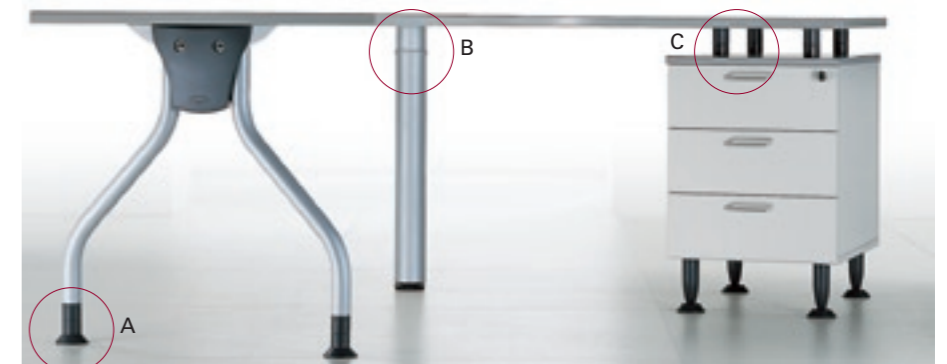

Bull Finiture cromatiche Colour finishing

Bull1

Piani di lavoro in melaminico sp. 25 mm con bordi in ABS sp. 2 mm.
 Melamine working tops 25 mm thick with edges in ABS 2 mm thick.
 Plateaux de travail mélaminé ép. 25 mm avec chants en ABS ép. 2 mm.
 Tischplatten in Melamin St. 25 mm mit ABS-Kanten St. 2 mm.
 Sobre de trabajo de melamina 25 mm de grosor con cantos de ABS 2 mm de grosor.
 Plano de trabalho em melamínico com espessura de 25 mm com bordos em ABS com espessura de 2 mm.



G Grigio chiaro Light grey - Gris clair Hellgrau - Gris claro Cinza claro	A-K Acero - Maple Erable - Ahorn Arce - Bordô	F Faggio - Beech Hêtre - Buche Haya - Faggio	P Pero - Pear Poirier - Birne Peral - Peroba
--	---	--	--

Bull4

Piani di lavoro in melaminico sp. 30 mm con bordi in ABS sp. 2 mm.
 Melamine working tops 30 mm thick with edges in ABS 2 mm thick.
 Plateaux de travail mélaminé ép. 30 mm avec chants en ABS ép. 2 mm.
 Tischplatten in Melamin St. 30 mm mit ABS-Kanten St. 2 mm.
 Sobre de trabajo de melamina 30 mm de grosor con cantos de ABS 2 mm de grosor.
 Plano de trabalho em melamínico com espessura de 30 mm com bordos em ABS com espessura de 2 mm.



G Grigio chiaro Light grey - Gris clair Hellgrau - Gris claro Cinza Claro	F Faggio - Beech Hêtre - Buche Haya - Faggio
--	--

Strutture metalliche disponibili nel colore alluminio.
 Metal structures available in aluminium colour.
 Structures métalliques disponibles dans le coloris aluminium.
 Metallstrukturen in der Farbe Aluminium verfügbar.
 Estructuras metálicas disponibles en el color aluminio.
 Estruturas metálicas disponíveis na cor alumínio.

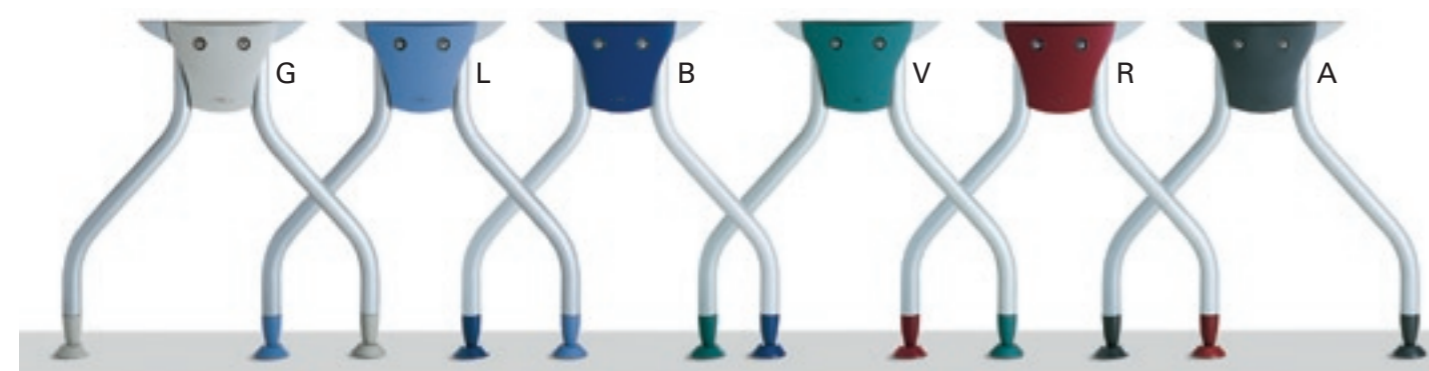

Frontal panels, mensole e appendici in MDF - Mascherine e puntali in ABS.
 Frontal panels, shelves and front shelves in MDF - ABS cases and ferrules.
 Panneaux frontaux, rehaussees et appendices en MDF - Masques et embouts en ABS.
 Sichtblenden, Borde und Anschlusskonsolen aus MDF - Abdeckungen und Spitzen aus ABS.
 Paneles frontales, repisas y elementos adicionales en MDF - Máscaras y extremos en ABS.
 Painéis frontais, mensulas e apêndices em MDF - Máscaras e ponteiros em ABS.



W* Bianco - White Blanc - Weiß Blanco - Branco	G Grigio platino Platinum grey Gris platine Platingrau Gris platino Cinza Platina	L Lilla - Lilac - Lilas Lila - Lila - Lilás	B Blu - Blue - Bleu Blau - Azul - Azul	V Verde marino Sea green Vert marin Meergrün Verde marino Verde marinho	R Rosso - Red Rouge - Rot Rojo - Vermelho	A Antracite Anthracite Anthracite Anthraxit Antracita Cinza chumbo
--	--	--	---	--	---	---

(*) Colore disponibile solo per frontal panels, mensole e appendici - Colour available for frontal panels, shelves and front shelves only
 Coloris disponible uniquement pour panneaux-frontaux, rehaussees et appendices - Farbe nur für Sichtblenden, Borde und Anschlusskonsolen verfügbar
 Color disponible solo para paneles frontales, repisas y elementos adicionales frontales - Cores disponíveis apenas para painéis frontais, mensulas e apêndices.

Maniglia di serie per ante e cassetti.
 Standard handle for doors and drawers.
 Poignée standard pour portes et tiroirs.
 Standardgriff für Türen und Schubladen.
 Tirador de serie para puertas y cajones.
 Puxador de série para portas e gavetas.



Bull

TAVOLI SCRIVANIA - DESKS **TAVOLI DATTELO / ALLUNGHI - TYPING TABLES / EXTENSIONS**

P 80 - H 72



BQ0080_ L 80
BQ0130_ L 130
BQ0160_ L 160
BQ0180_ L 180

BQ0201_ L 200

BQ0088_ L 80
BQ9202_ L 130
BQ9212_ L 160
BQ9222_ L 180

BQ9233_ L 200

P 60 - H 72



BQ0083_ L 80
BQ0115_ L 110

BQ0085_ L 80
BQ0117_ L 110

L 110 - P 60 - H 72

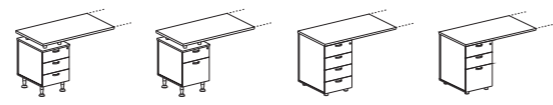

BQ0118_ **BQ0119_** **BQ0120_** **BQ0123_**

TAVOLI COMPATTI (Dx o Sx) - COMPACT DESKS (RH or LH)

L 160 - P 160 - H 72

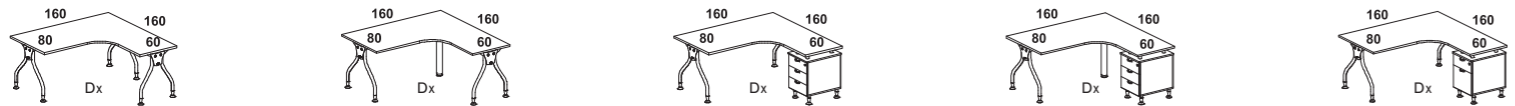

BQ9006_ Dx
BQ9001_ Sx

BQ9026_ Dx
BQ9021_ Sx

BQ9007_ Dx
BQ9002_ Sx

BQ9027_ Dx
BQ9022_ Sx

BQ9008_ Dx
BQ9003_ Sx

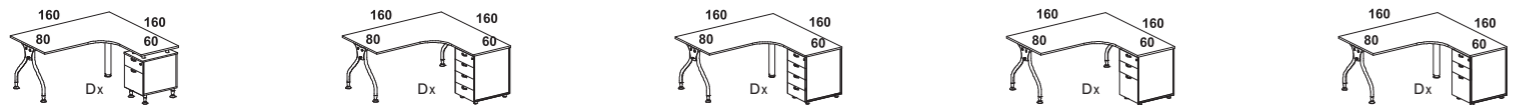

BQ9028_ Dx
BQ9023_ Sx

BQ9120_ Dx
BQ9110_ Sx

BQ9122_ Dx
BQ9112_ Sx

BQ9180_ Dx
BQ9170_ Sx

BQ9182_ Dx
BQ9172_ Sx

L 160 - P 202,5 - H 72

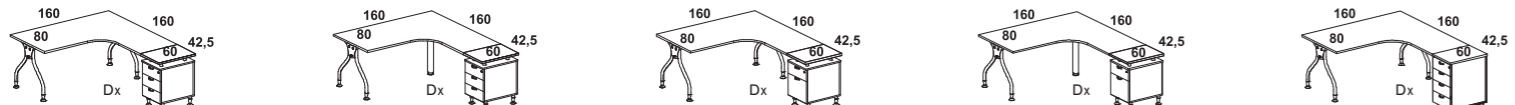

BQ9009_ Dx
BQ9004_ Sx

BQ9029_ Dx
BQ9044_ Sx

BQ9010_ Dx
BQ9005_ Sx

BQ9030_ Dx
BQ9025_ Sx

BQ9121_ Dx
BQ9111_ Sx

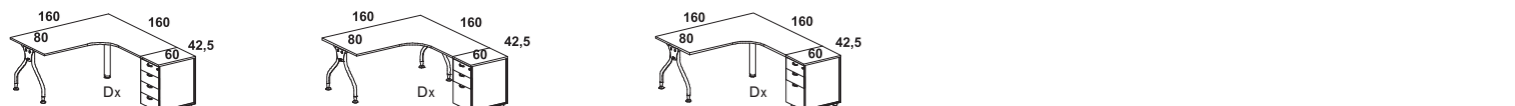

BQ9123_ Dx
BQ9113_ Sx

BQ9181_ Dx
BQ9171_ Sx

BQ9183_ Dx
BQ9173_ Sx

TAVOLI COMPOSTI - COMPOUND DESKS

L 130 - P 130 - H 72

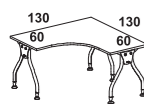

BQ9050_

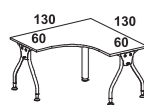

BQ9070_

L 172,5 - P 130 - H 72

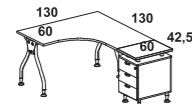

BQ9054_

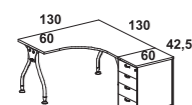

BQ9141_

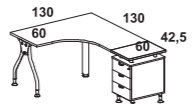

BQ9074_

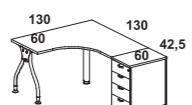

BQ9154_

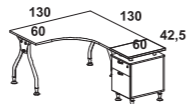

BQ9055_

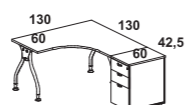

BQ9041_

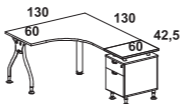

BQ9075_

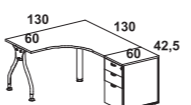

BQ9044_

CASSETTIERE - PEDESTALS **ELEMENTI DI SERVIZIO - SERVICE UNITS**

L 42,5 - P 57 - H 56

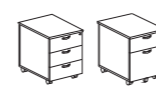

BQ3001_ **BQ3002_**

L 42 - P 57,5 - H 58

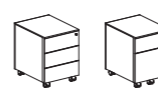

AC3001_ **AC3002_**
METALLICHE
METALLIC

L 42,5 - P 60 - H 72

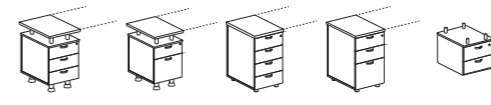

BQ3007_ **BQ3008_** **BQ3031_** **BQ3032_** **BQ3003_**

L 42 - P 53 - H 43



DK3005A

L 90 - P 58 - H 72



BQ3005_

L 90 - P 60 - H 65



BQ3997_ L 50,5

P 50,5 - H 67+72



BQ3998_ L 80,5

SATELLITI - SATELLITES **APPENDICE FRONTALE - FRONTAL SHELF** **MODESTY PANELS**

L 80 - P 71 - H 72



BQ3010_ **BQ3011_**

L 80 - P 71 - H 80



BQ3012_

L 50 - H 48



AC5050HH

ø 1



MN0507H

L 160 - P 20 - H 2,5

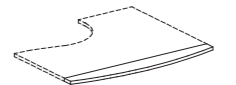

BQ6190_

P 1,8 - H 35



BQ1080_ L 67
BQ1110_ L 97
BQ1130_ L 117
BQ1160_ L 147
BQ1180_ L 167

TAVOLI RIUNIONE - MEETING TABLES

ø 120 - H 72



BQ0121_

L 80 - P 71 - H 80



BQ0122_

P 100 - H 72



BQ0200_ L 200
BQ0250_ L 250

L 300/350 - P 100 - H 72



DA COMPORRE
TO BE COMPOUND

L 206/236 - P 126 - H 72



DA COMPORRE
TO BE COMPOUND

L 296/326/346 - P 166 - H 72



DA COMPORRE
TO BE COMPOUND

RACCORDI - CONNECTION ELEMENTS

L 80 - H 2,5

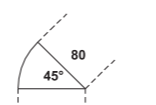

BQ2001_

L 60 - P 60 - H 2,5

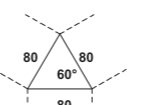

BQ2003_

L 80 - P 80 - H 2,5

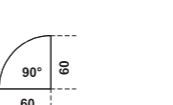

BQ2012_

L 80 - P 80 - H 2,5

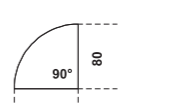

BQ2002_

L 80 - P 60 - H 2,5

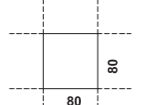

BQ2004_

L 80 - P 60 - H 2,5

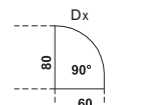

BQ2010_

L 80 - P 60 - H 2,5

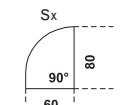

BQ2011_

RACCORDI SU COLONNA O GAMBONE - CONNECTION ELEMENTS WITH SLIM COLUMN OR COLUMN

L 110/130 - P 110/130 - H 72



BQ2033_ L 110
BQ2034_ L 130

BQ2013_ L 110
BQ2014_ L 130

L 120 - P 120 - H 72

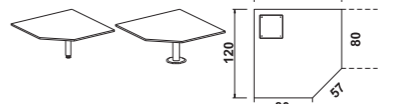

BQ2025_ **BQ2005_**

L 80 - P 40 - H 72



BQ2016_

L 100 - P 50 - H 72



BQ2028_ **BQ2008_**

L 126/166 - P 63/83 - H 72

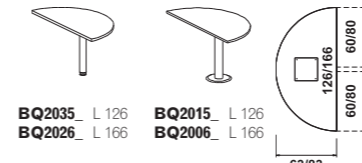

BQ2035_ L 126
BQ2026_ L 166

BQ2015_ L 126
BQ2006_ L 166

L 90 - P 90 - H 72

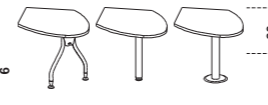

BQ2020_ **BQ2041_** **BQ2021_**

L 110 - P 110 - H 72



BQ2022_ **BQ2043_** **BQ2023_**

L 91 - P 137 - H 72

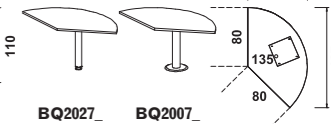

BQ2027_ **BQ2007_**

BULL 4

Piani di lavoro in melaminico sp. 30 mm con bordi perimetrali in ABS
Worktops in melamine 30 mm thick with perimetrical edges in ABS

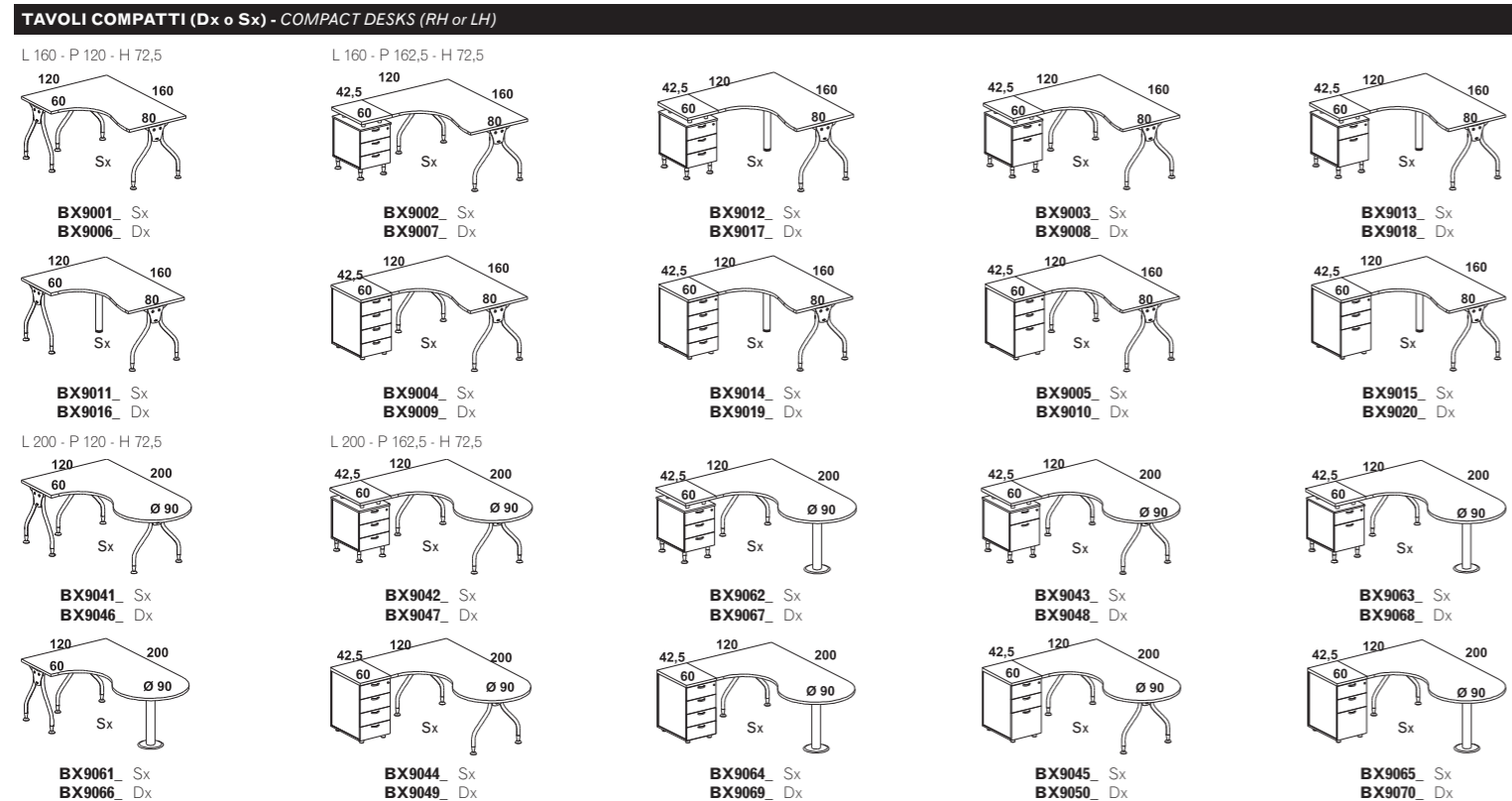
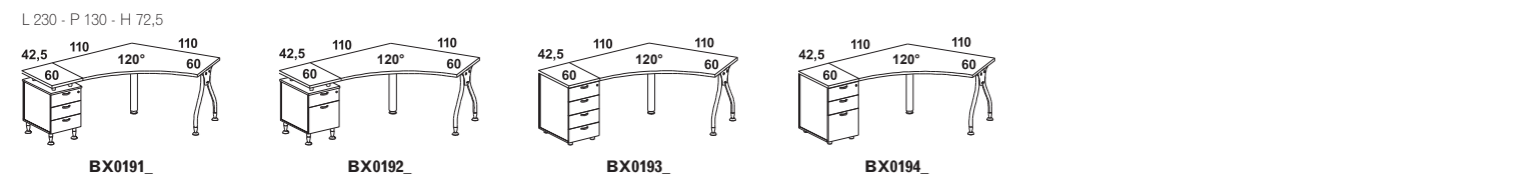
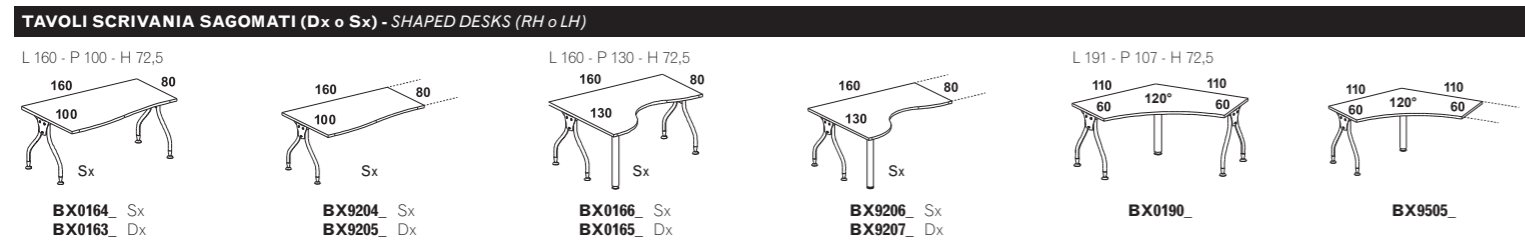
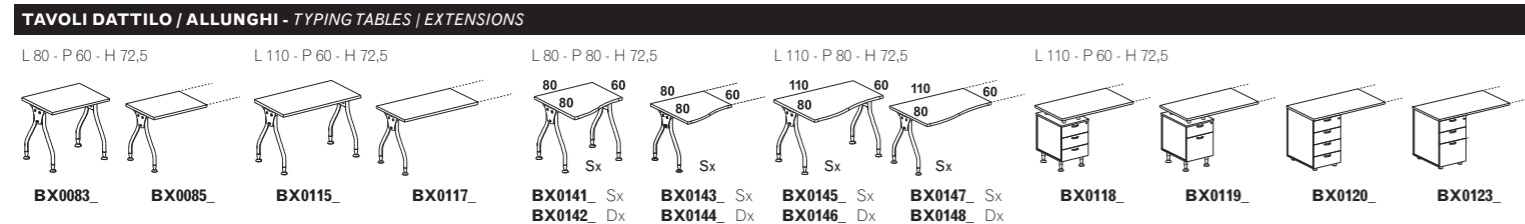
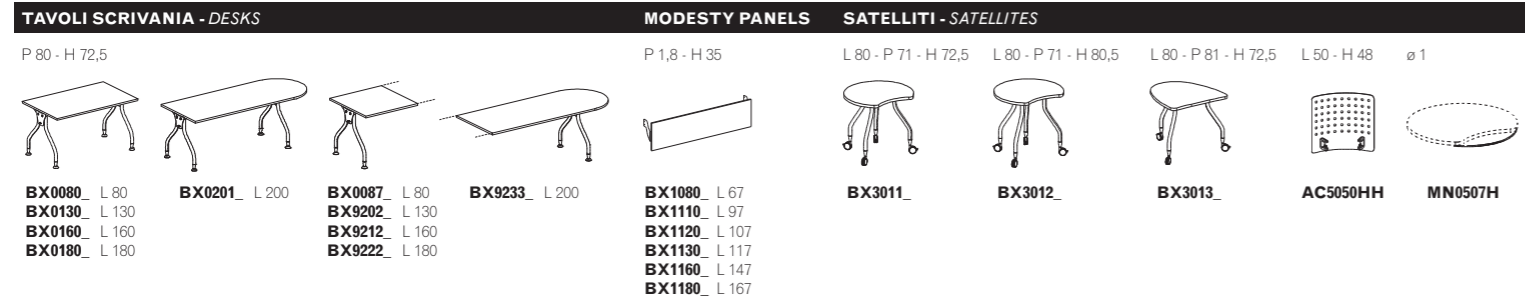
**BULL 4**

Piani di lavoro in melaminico sp. 30 mm con bordi perimetrali in ABS
Worktops in melamine 30 mm thick with perimetrical edges in ABS

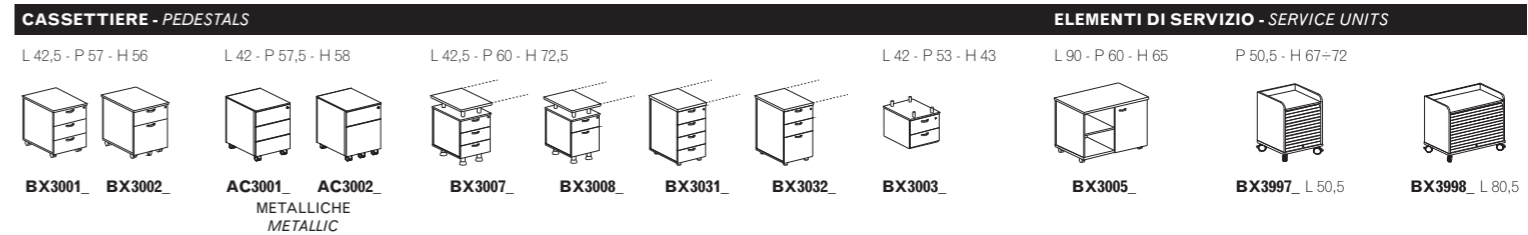
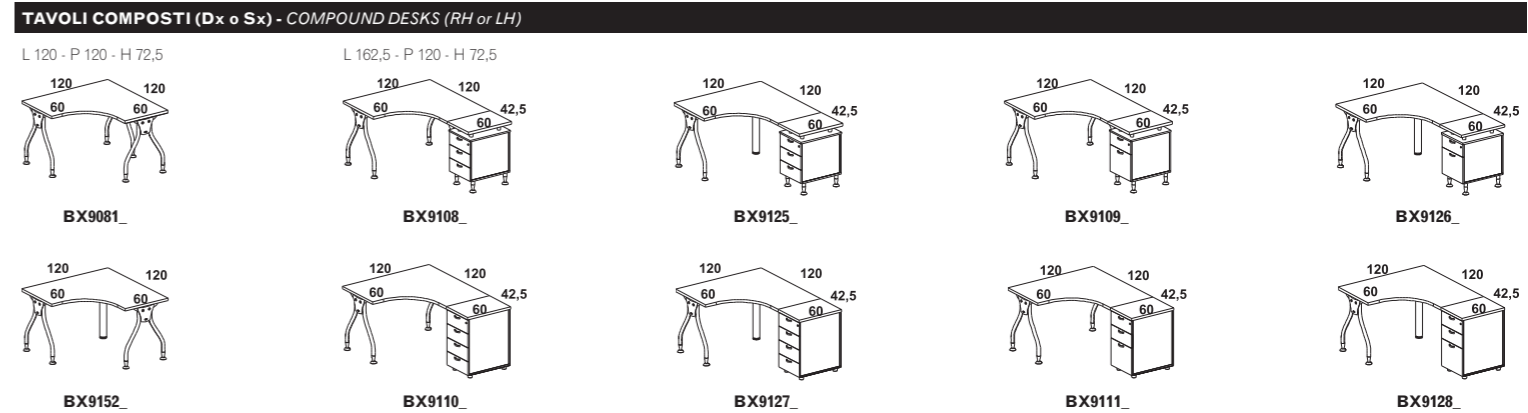
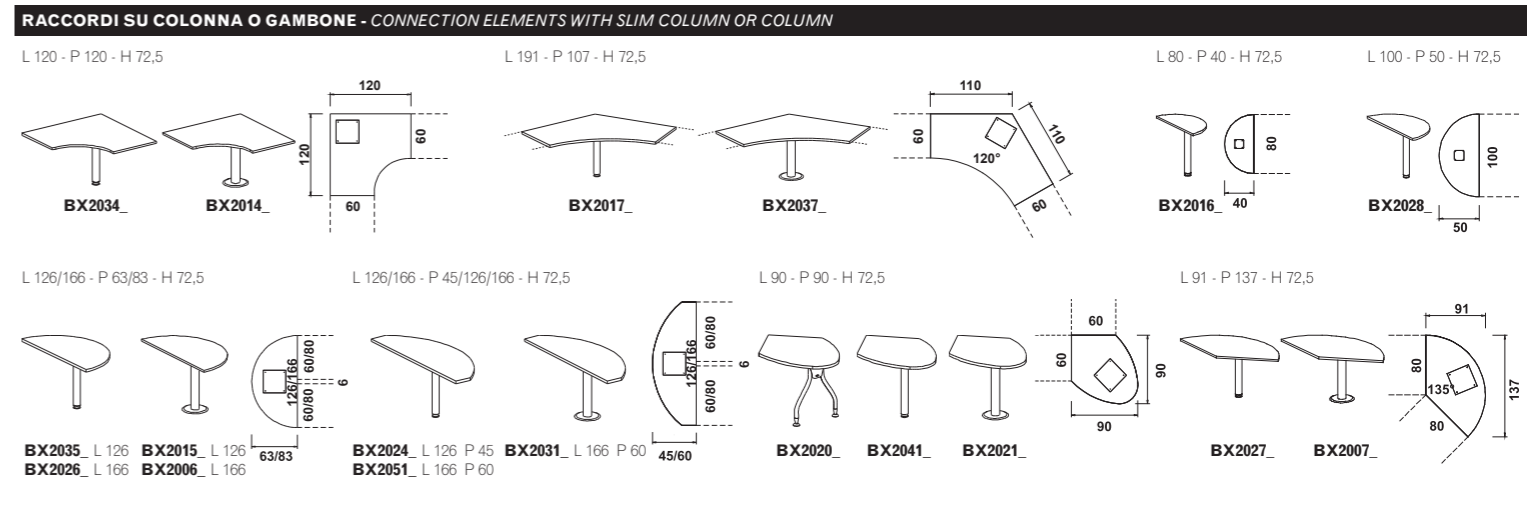
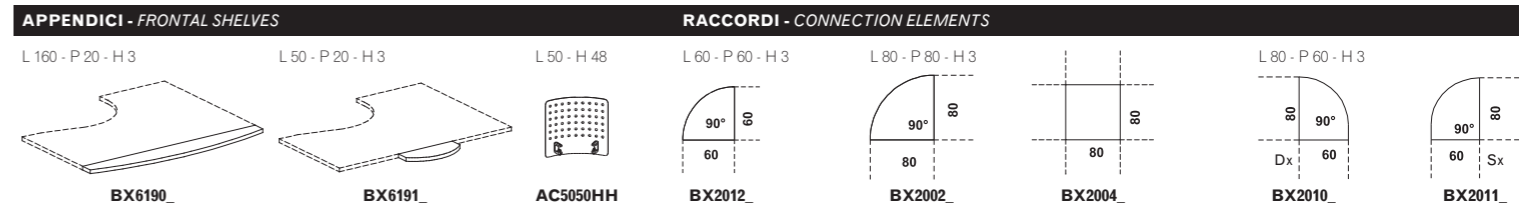
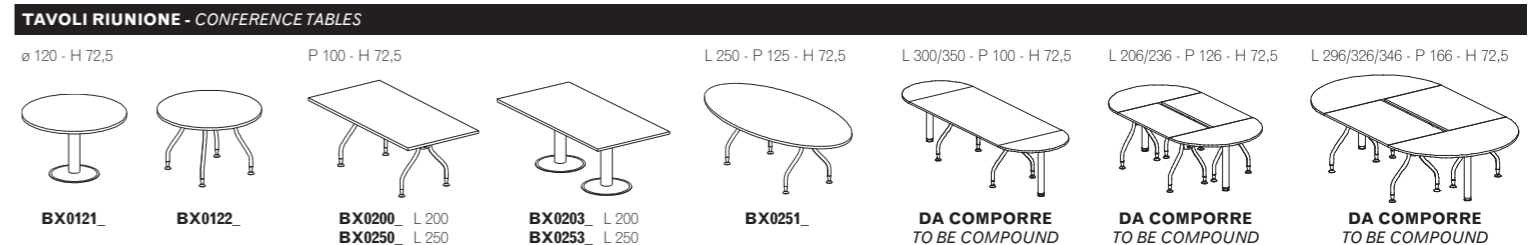
**ELEMENTI DI SERVIZIO - SERVICE UNITS**

BULL 1/ BULL 4

FRONTAL PANELS E MENSOLE - FRONTAL PANELS AND SHELVES

P1 - H 48	P30 - H 27	P31 - H 48	P3 - H 37	P3 - H 43
AC5060_ L 60	AC5080_ L 80 AC5100_ L 100 AC5110_ L 110 AC5120_ L 120 AC5130_ L 130 AC5160_ L 160 AC5180_ L 180	AC6110_ L 110 AC6130_ L 130 AC6160_ L 160 AC6180_ L 180	AC5508HH L 80 AC5513HH L 130 AC5516HH L 160	AC5528HH L 80 AC5523HH L 130 AC5526HH L 160

ACCESSORI PER FRONTAL PANELS E BARRE PORTACCESSORI - ACCESSORIES FOR FRONTAL PANELS AND HOLDER BARS

L6,5 - P6,5 - H8,5	L50 - P17 - H3	L34 - P23 - H23	L27 - P22 - H22	L12 - P22 - H28	L23 - P31 - H5	L31 - P22 - H5	L30 - P23 - H10	L23 - P10 - H29	L21 - P1 - H15	L18 - P13 - H12
AC5490H	AC5491H	AC5492H	AC5494H	AC5483H	AC5493H	AC5482H	AC5485H	AC5486H	AC5487H	AC5498H

ACCESSORI - ACCESSORIES

AC0433R	AC0379R	AC0516RH	AC0508_G	AC6501HA	AC0432R	AC0445R	AC0434G		
AC0436G	AC0442R	AC0600H	AC0385H L 56 AC0388H L 80	AC0389H	AC0510H	AC0519_	AC0512R	AC0511R	AC0381H
AC1520HH L 60 AC1521HH L 90 AC1525HH L 100 AC1522HH L 110 AC1523HH L 140 AC1524HH L 160	AC1520H L 60 AC1521H L 90 AC1525H L 105 AC1522H L 115 AC1523H L 145 AC1524H L 165	AC1557H L 45 AC1550H L 58 AC1558H L 78 AC1551H L 88 AC1555H L 100 AC1552H L 110 AC1553H L 140 AC1554H L 160	AC1535G L 24 AC1536G L 50 AC1530G L 60 AC1531G L 90 AC1532G L 110 AC1533G L 140 AC1534G L 160	AC0377HR ø8	AC0372_ ø6 AC0376_ ø8	AC0380H	AC0382H		

LIBRERIE - BOOKCASES

L180 - P34 - H130,5	L180 - P36 - H130,5	L180 - P34 - H133,5	L180 - P36 - H133,5	L180 - P34 - H148,5	L180 - P36 - H148,5	L180 - P36 - H2,5	L130,5 - P34 - H198
MQ4350_	MQ4355_H	MQ4360_H	MQ4365_H	MQ4370_H	MQ4375_H	MQ4241_	MQ4380_H

BULL 1/ BULL 4

CONTENITORI - STORAGE UNITS

CONTENITORI BASSI - LOW STORAGE UNITS

L45 - H 73,5	L90 - H 73,5	L45 - H 85	L90 - H 85
MQ4300_ P 43	MQ4001_ P 45	MQ4002_ P 45	MQ4000_ P 45
MQ4310_ P 43	MQ4003_ P 45	MQ4004_ P 45	MQ4313_ P 43
MQ4086_ P 45	MQ4315_ P 43	MQ4087_ P 45	

CONTENITORI MEDI - MEDIUM STORAGE UNITS

L45 - H 136	L90 - H 136
MQ4320_ P 43	MQ4005_ P 45
MQ4006 (A) P 44 * (B)	MQ4330_ P 43
MQ4007_ P 45	MQ4008 (A) P 44 * (B)
MQ4331_ P 45	

CONTENITORI ALTI - HIGH STORAGE UNITS

L45 - H 206,5	L90 - H 206,5
MQ4009_ P 43	MQ4022_ P 45
MQ4024_ P 45	MQ4025_ P 45
MQ4010_ P 45	MQ4018_ P 45
MQ4026_ P 45	MQ4011 (A) P 45 * (B)
MQ4019 (A) P 45 * (B)	MQ4027 (A) P 45 * (B)
MQ4340_ P 43	MQ4029_ P 45
MQ4015_ P 45	
MQ4012_ P 43	MQ4023_ P 45
MQ4028_ P 45	MQ4013_ P 45
MQ4020_ P 45	MQ4014 (A) P 45 * (B)
MQ4021 (A) P 45 * (B)	MQ4345_ P 43
MQ4347 (B) P 45	MQ4017_ P 45
MQ4346_ P 45	MQ4347 (B) P 45
MQ4016_ P 45	

TOP - TOPS	ZOCCOLI METALLICI (OPTIONAL) - BASE METAL FRAMES (OPTIONAL)
P 45 - H 2,5	P 41,5 - H 2,8
MQ4201_ L 45	AC0514_ L 45
MQ4202_ L 90	AC0513_ L 90
MQ4203_ L 135	
MQ4204_ L 180	
MQ4205_ L 225	
MQ4206_ L 270	

TIPOLOGIE ANTE VETRO DISPONIBILI - GLASS DOORS AVAILABLE

A: Anta vetro fumé (standard) **B:** Anta vetro acidato con telaio in alluminio dotata di serratura (optional)
Smoked-grey glass door (standard) Acetated glass door with aluminium frame and lock (optional)

* Per il codice consultare il listino prezzi / For the code, see price list.

I CONTENITORI FISSI SONO COMPONIBILI, SOVRAPPONIBILI E VANNO COMPLETATI CON I TOP SP. 2,5 CM. I CODICI RIPORTATI SI RIFERISCONO A CONTENITORI CON RIPIANI IN MELAMINICO. THE FREE-STANDING STORAGE UNITS ARE MODULAR, SUPERIMPOSABLE AND HAVE TO BE COMPLETED WITH TOPS 2,5 CM THICK. THE CODES ARE RELATED TO STORAGE UNITS WITH MELAMINE SHELVES.

CONTENITORI SU PIEDINI - STORAGE UNITS ON FEET **CONTENITORI SU RUOTE - STORAGE UNITS ON CASTORS**

L90 - P 47 - H 77,5	L90 - P 47 - H 140	L90 - P 47 - H 86	L90 - P 47 - H 148
MQ4059_	MQ4060_	MQ4061_	MQ4050_
MQ4062 (A) MQ4063 (B)	MQ4064_	MQ4055_	MQ4056 (A) MQ4057 (B)
MQ4058_			

TUTTI I CONTENITORI SU PIEDINI E SU RUOTE SONO COMPRESIVI DI BASE, TOP E SCHIENA DI FINITURA (+ MANIGLIA SOLO PER CONTENITORI SU RUOTE) ALL THE STORAGE UNITS ON FEET AND CASTORS ARE PROVIDED WITH BASE, TOP AND FINISHING BACK (+ HANDLE FOR STORAGE UNITS ON CASTORS ONLY)